

Metal Laboratory Casework

product catalog





Since 1975, Air Master Systems has manufactured chemical fume hoods, filtration hoods, and laboratory furniture for the research & development, institutional, industrial, government and biotech markets.



Contents

Cabinet Specifications	4
Ordering Guide	5
Options Menu	6
Base Cabinets — Standing Height	8
Open Cabinets	8
Door Cabinets	8
Drawer Cabinets	9
Door & Drawer Cabinets	12
Shelves & Pull Out Shelves	16
Corner Cabinets	16
Three or Five Equal Drawer Cabinet	17
Sink & Fume Hood Cabinets	18
Base Cabinets — Sitting Height	19
Open Cabinets	19
Door Cabinets	19
Drawer Cabinets	20
Door & Drawer Cabinets	23
Sink & Fume Hood Cabinets	25
Corner Cabinets	26
Base Cabinets — ADA Height	27
Open Cabinets	27
Door Cabinets	27
Drawer Cabinets	28
Door & Drawer Cabinets	29
Corner Cabinets	30
Sink & Fume Hood Cabinets	31
Base Cabinets — Corrosives & Flammables	33
Corrosives Storage Cabinets	33
Flammables Storage Cabinets	34
Vacuum Pump Cabinets	35
Mobile Cabinets	37
Hanging Cabinets	38
Tall Cabinets	39
Wall Cabinets — 24" Height	41
Wall Cabinets — 30" Height	43
Wall Cabinets — 36" Height	45
Wall Cabinets — 48" Height	47
Aprons	49
Utility Tables	50
Knee Space Rails and Panels	51
Filler Panels	53
Accessories	54

Note:

Images in this catalog are for representation only. For complete product specifications, contact your AMS representative.

Cabinet Specifications

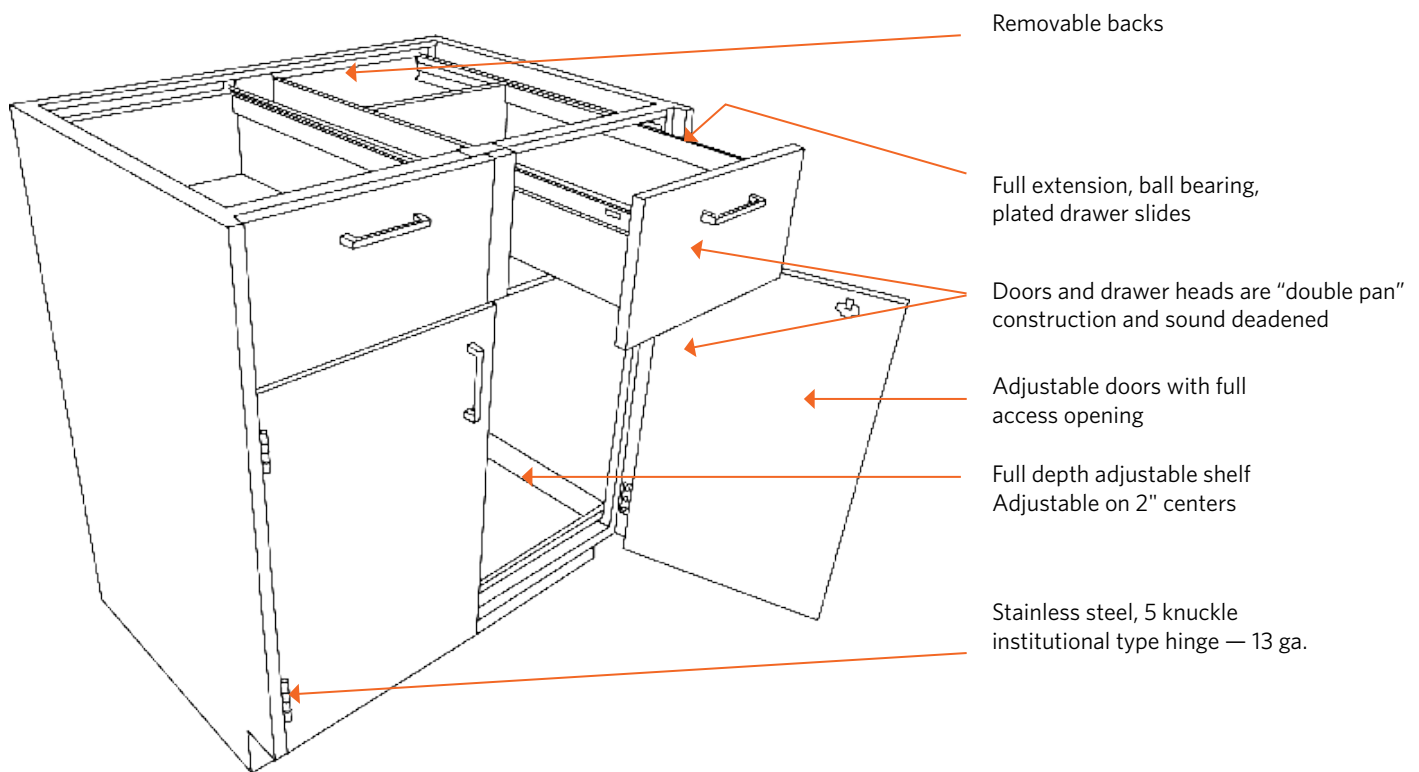

All surfaces shall be painted or zinc plated. The paint is chemical and UV resistant baked on epoxy-hybrid powder. Specific test data is available upon request.

Gauges of base cabinet components

Aprons	18 ga.
Back Panels	18 ga.
Bottom Panels	18 ga.
Drawer/Door Outer Panel	20 ga.
Door Inner Panel	20 ga.
Drawer Bodies	20 ga.
Legs - 2"sq. tube	16 ga.
Shelves	18 ga.
Side Panels	18 ga.
Table Frames	18 ga.
Security Panels	20 ga.

For complete specifications, request our full line of product specifications. Subject to change.

Ordering Guide

S	TYPE	HEIGHT	WIDTH	STYLE	OPTIONS
Cabinet Type					
B	Base (Inset)				
F	Floor (Tall)				
HB	Hanging Base				
OB	Overlay Base				
MB	Mobile Base				
W	Wall				
ASB	Acid Storage Base				
FSB	Flammable Storage				
Base Cabinet Height					
29"	Sitting Height				
32"	ADA Height				
35"	Standing Height				
Wall Cabinet Height					
24"	30"	36"	48"		
Cabinet Width					
12"	15"	18"	21"	24"	30"
36"	42"	48"			
Cabinet Style					
Reference AMS catalog for door and drawer configurations					
Option Suffix (for base cabinet)					
-18	Depth(contact AMS for approval)	-PS	1 Pull Out Shelf		
-LK	Locks	-2PS	2 Pull Out Shelves		
-LTK	Toe Kick On Left Side Of Cabinet	-3PS	3 Pull Out Shelves		
-RTK	Toe Kick On Right Side Of Cabinet	-VK	Vent Kit (only for acid cabinet)		
-SS	Stainless Steel, Type 304	-VD	Vertical Divider		
-SS316	Stainless Steel, Type 316	-FB	Finished Backs		
-BB	Bread Board(selected models only)	-EC	End Covers		
Option Suffix (for wall cabinet)					
-16	16" Depth	-TG	Tempered Glass		
-LK	Locks	-LG	Laminate (safety) Glass		
-SS	Stainless Steel, Type 304	-THB	Titan Hanging Bracket		
-SS316	Stainless Steel, Type 316				
Option Suffix (for mobile cabinet)					
-18	Depth(contact AMS for approval)	-T	3/4" THK. Metal Top		
-LK	Locks	-E	3/4" THK. Epoxy Top		
-SS	Stainless Steel, Type 304	-P	3/4" THK. Phenolic Top		
-SS316	Stainless Steel, Type 316	-2"	Casters (in lieu of standard 3")		
-BB	Bread Board (selected models only)				
Option Suffix (for tall cabinet)					
-LK	Locks	-LG	Laminate (safety) Glass		
-SS	Stainless Steel, Type 304	-WB	Wardrobe Bracket		
-SS316	Stainless Steel, Type 316	-PS	1 Pull Out Shelves		
-TG	Tempered Glass				

Options Menu

DOOR & DRAWER FRONTS



- Inset steel
(Standard Default)



- Flush overlay

DRAWER SLIDES & CASTERS



- 100 lb. full extension
(Standard Default)
- 100 lb. full extension
soft close



- 3" Caster (Default)
- 2" Caster

HINGES & ROLLERS



- Inset Steel
- Stainless steel 5-knuckle
(Standard Default)



- Flush Overlay
- Stainless steel 5-knuckle
(Standard Default)

MAGNETIC CATCH



- Magnetic catch
(Standard Default)
- Roller catch

LOCKS

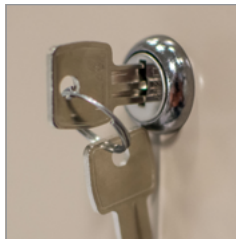

- Master 5-pin
(Standard Default)

Options Menu

PULLS



Rectangular brushed aluminum



Recessed aluminum
 Painted recessed aluminum
AMS standard colors available



Aluminum wire pulls
 Stainless steel wire pulls

LABEL HOLDERS



None(Standard Default)
 One each door and drawer
 One per pair of doors and each drawer

BASE UNIT SHELF



One piece adjustable
(Standard Default)

GLASS FRAMED DOORS



3/16" clear float glass
(Standard Default)
 1/4" laminated safety glass
 1/4" tempered safety glass

SECURITY PANELS

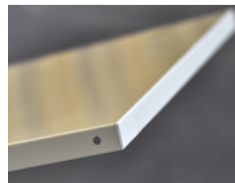

Without security panel
(Standard Default)
 With security panel

Base Cabinets — Standing Height

Standing height base cabinets are 34.75" high and 22.375" deep. Units are available in various widths as shown. Door units feature a single shelf as standard. All open units have 2 shelves. Additional shelves are available. Specify left- or right-hinged doors using the suffix "L" or "R". If locks are required use the suffix "LK". If finished Back is required use the suffix "FB".

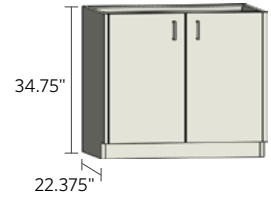

OPEN CABINETS

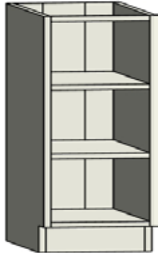

Up to 24" wide

Width	Item Number
12"	SB3512-000
15"	SB3515-000
18"	SB3518-000
21"	SB3521-000
24"	SB3524-000

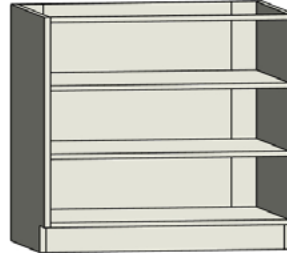

30" and wider

Width	Item Number
30"	SB3530-000
36"	SB3536-000
42"	SB3542-000
48"	SB3548-000

DOOR CABINETS

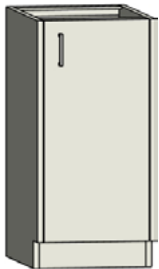

Example: SB3515-100R

Width	Left & Right Hinged
12"	SB3512-100L
15"	SB3515-100L
18"	SB3518-100L
21"	SB3521-100L
24"	SB3524-100L
12"	SB3512-100R
15"	SB3515-100R
18"	SB3518-100R
21"	SB3521-100R
24"	SB3524-100R

Note: L(left) or R(right) refers to door hinge side.



30" and wider

Width	Item Number
30"	SB3530-200
36"	SB3536-200
42"	SB3542-200
48"	SB3548-200

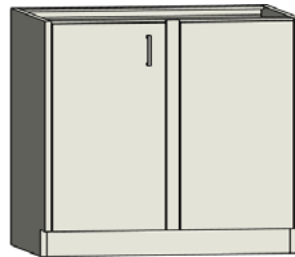

Example: SB3530-100-LPNL

Width	Left & Right Hinged
30"	SB3530-100-LPNL
36"	SB3536-100-LPNL
42"	SB3542-100-LPNL
48"	SB3548-100-LPNL
30"	SB3530-100-RPNL
36"	SB3536-100-RPNL
42"	SB3542-100-RPNL
48"	SB3548-100-RPNL

Note: L(left) or R(right) refers to door hinge side. PNL(panel) refers to panel next to door

Base Cabinets — Standing Height

Standing height base cabinets are 34.75" high and 22.375" deep. Units are available in various widths as shown. Drawer units feature 100 lb. full extension slides as standard. If locks are required use the suffix "LK". If finished Back is required use the suffix "FB".

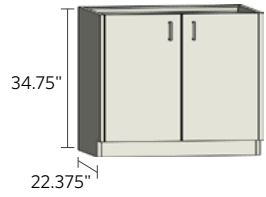

DRAWER CABINETS



Up to 24" wide

Width	Item Number
12"	SB3512-032
15"	SB3515-032
18"	SB3518-032
21"	SB3521-032
24"	SB3524-032



30" and wider

Width	Item Number
30"	SB3530-032
36"	SB3536-032
42"	SB3542-032
48"	SB3548-032



Up to 24" wide

Width	Item Number
12"	SB3512-024
15"	SB3515-024
18"	SB3518-024
21"	SB3521-024
24"	SB3524-024



30" and wider

Width	Item Number
30"	SB3530-028
36"	SB3536-028
42"	SB3542-028
48"	SB3548-028



Up to 24" wide

Width	Item Number
12"	SB3512-008
15"	SB3515-008
18"	SB3518-008
21"	SB3521-008
24"	SB3524-008



30" and wider

Width	Item Number
30"	SB3530-008
36"	SB3536-008
42"	SB3542-008
48"	SB3548-008



Up to 24" wide

Width	Item Number
12"	SB3512-040
15"	SB3515-040
18"	SB3518-040
21"	SB3521-040
24"	SB3524-040



30" and wider

Width	Item Number
30"	SB3530-040
36"	SB3536-040
42"	SB3542-040
48"	SB3548-040

Base Cabinets — Standing Height

Standing height base cabinets are 34.75" high and 22.375" deep. Units are available in various widths as shown. Drawer units feature 100 lb. full extension slides as standard. If locks are required use the suffix "LK". If finished Back is required use the suffix "FB".

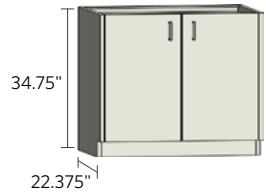

drawers lock
SB3542-0(10)0-LK
 height width door half drawer

height drawer Qty File Drawers
SB3512-014-1F-LK
 width door half drawer Lock

DRAWER CABINETS



Up to 24" wide

Width	Item Number
12"	SB3512-012-1F
15"	SB3515-012-1F
18"	SB3518-012-1F
21"	SB3521-012-1F
24"	SB3524-012-1F



30" and wider

Width	Item Number
30"	SB3530-024-2F
36"	SB3536-024-2F
42"	SB3542-024-2F
48"	SB3548-024-2F



Up to 24" wide

Width	Item Number
12"	SB3512-000-2F
15"	SB3515-000-2F
18"	SB3518-000-2F
21"	SB3521-000-2F
24"	SB3524-000-2F



30" and wider

Width	Item Number
30"	SB3530-000-4F
36"	SB3536-000-4F
42"	SB3542-000-4F
48"	SB3548-000-4F



Up to 24" wide

Width	Item Number
12"	SB3512-004-1F
15"	SB3515-004-1F
18"	SB3518-004-1F
21"	SB3521-004-1F
24"	SB3524-004-1F



30" and wider

Width	Item Number
30"	SB3530-008-2F
36"	SB3536-008-2F
42"	SB3542-008-2F
48"	SB3548-008-2F



Up to 24" wide

Width	Item Number
12"	SB3512-020-1F
15"	SB3515-020-1F
18"	SB3518-020-1F
21"	SB3521-020-1F
24"	SB3524-020-1F



30" and wider

Width	Item Number
30"	SB3530-040-2F
36"	SB3536-040-2F
42"	SB3542-040-2F
48"	SB3548-040-2F

Base Cabinets — Standing Height

Standing height base cabinets are 34.75" high and 22.375" deep. Units are available in various widths as shown. Drawer units feature 100 lb. full extension slides as standard. If locks are required use the suffix "LK". If finished Back is required use the suffix "FB".

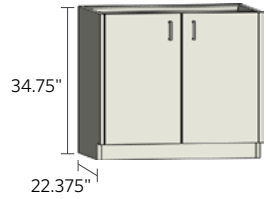

Example: SB3542-034-LK
 height width door half drawer drawer lock

DRAWER CABINETS



30" and wider

Width	Item Number
30"	SB3530-050
36"	SB3536-050
42"	SB3542-050
48"	SB3548-050



30" and wider

Width	Item Number
30"	SB3530-064
36"	SB3536-064
42"	SB3542-064
48"	SB3548-064



30" and wider

Width	Item Number
30"	SB3530-060
36"	SB3536-060
42"	SB3542-060
48"	SB3548-060



30" and wider

Width	Item Number
30"	SB3530-070
36"	SB3536-070
42"	SB3542-070
48"	SB3548-070



30" and wider

Width	Item Number
30"	SB3530-080
36"	SB3536-080
42"	SB3542-080
48"	SB3548-080



30" and wider

Width	Item Number
30"	SB3530-052
36"	SB3536-052
42"	SB3542-052
48"	SB3548-052



30" and wider

Width	Item Number
30"	SB3530-044
36"	SB3536-044
42"	SB3542-044
48"	SB3548-044



30" and wider

Width	Item Number
30"	SB3530-034
36"	SB3536-034
42"	SB3542-034
48"	SB3548-034

Base Cabinets — Standing Height

Standing height base cabinets are 34.75" high and 22.375" deep. Units are available in various widths as shown. Drawer units feature 100 lb. full extension slides as standard. Door units feature a single shelf as standard. Additional shelves are available. Specify left- or right-hinged doors using the suffix "L" or "R". If locks are required use the suffix "LK". If finished Back is required use the suffix "FB".

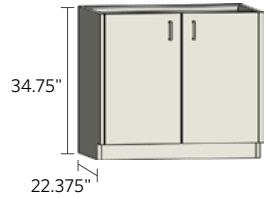

DRAWER CABINETS



Up to 24" wide

Width	Item Number
12"	SB3512-016
15"	SB3515-016
18"	SB3518-016
21"	SB3521-016
24"	SB3524-016



30" and wider

Width	Item Number
30"	SB3530-016
36"	SB3536-016
42"	SB3542-016
48"	SB3548-016



30" and wider

Width	Item Number
30"	SB3530-00(16)
36"	SB3536-00(16)
42"	SB3542-00(16)
48"	SB3548-00(16)

DOOR & DRAWER CABINETS

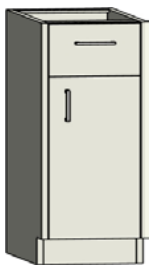

Right-hinged door shown

Width	Left & Right Hinged
12"	SB3512-110L
15"	SB3515-110L
18"	SB3518-110L
21"	SB3521-110L
24"	SB3524-110L
12"	SB3512-110R
15"	SB3515-110R
18"	SB3518-110R
21"	SB3521-110R
24"	SB3524-110R



Right-hinged door shown

Width	Left & Right Hinged
12"	SB3512-102L
15"	SB3515-102L
18"	SB3518-102L
21"	SB3521-102L
24"	SB3524-102L
12"	SB3512-102R
15"	SB3515-102R
18"	SB3518-102R
21"	SB3521-102R
24"	SB3524-102R

Base Cabinets — Standing Height

Standing height base cabinets are 34.75" high and 22.375" deep. Units are available in various widths as shown. Drawer units feature 100 lb. full extension slides as standard. Door units feature a single shelf as standard. Additional shelves are available. Specify left- or right-hinged doors using the suffix "L" or "R". If locks are required use the suffix "LK". If finished Back is required use the suffix "FB".

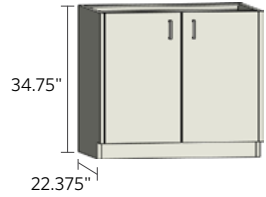

height
drawer
lock
SB3536-220-LK
width
door
half drawer

DOOR & DRAWER CABINETS



30" and wider

Width	Item Number
30"	SB3530-212
36"	SB3536-212
42"	SB3542-212
48"	SB3548-212



30" and wider

Width	Item Number
30"	SB3530-220
36"	SB3536-220
42"	SB3542-220
48"	SB3548-220



30" and wider

Width	Item Number
30"	SB3530-202-A
36"	SB3536-202-A
42"	SB3542-202-A
48"	SB3548-202-A



Right-hinged door shown

Width	Left & Right Hinged
30"	SB3530-202-BL
36"	SB3536-202-BL
42"	SB3542-202-BL
48"	SB3548-202-BL
30"	SB3530-202-BR
36"	SB3536-202-BR
42"	SB3542-202-BR
48"	SB3548-202-BR



30" and wider

Width	Item Number
30"	SB3530-204
36"	SB3536-204
42"	SB3542-204
48"	SB3548-204



Right-hinged door shown

Width	Left & Right Hinged
30"	SB3530-142L
36"	SB3536-142L
42"	SB3542-142L
48"	SB3548-142L
30"	SB3530-142R
36"	SB3536-142R
42"	SB3542-142R
48"	SB3548-142R



Right-hinged door shown

Width	Left & Right Hinged
30"	SB3530-118L
36"	SB3536-118L
42"	SB3542-118L
48"	SB3548-118L
30"	SB3530-118R
36"	SB3536-118R
42"	SB3542-118R
48"	SB3548-118R



Right-hinged door shown

Width	Left & Right Hinged
30"	SB3530-118-AL
36"	SB3536-118-AL
42"	SB3542-118-AL
48"	SB3548-118-AL
30"	SB3530-118-AR
36"	SB3536-118-AR
42"	SB3542-118-AR
48"	SB3548-118-AR

Base Cabinets — Standing Height

Standing height base cabinets are 34.75" high and 22.375" deep. Units are available in various widths as shown. Drawer units feature 100 lb. full extension slides as standard. Door units feature a single shelf as standard. Additional shelves are available. Specify left- or right-hinged doors using the suffix "L" or "R". If locks are required use the suffix "LK". If finished Back is required use the suffix "FB".

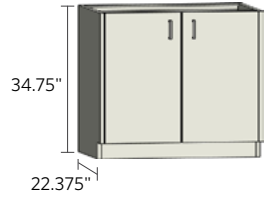

DOOR & DRAWER CABINETS



Right-hinged door shown

Width	Left & Right Hinged
30"	SB3530-140L
36"	SB3536-140L
42"	SB3542-140L
48"	SB3548-140L
30"	SB3530-140R
36"	SB3536-140R
42"	SB3542-140R
48"	SB3548-140R



Right-hinged door shown

Width	Left & Right Hinged
30"	SB3530-140-BL
36"	SB3536-140-BL
42"	SB3542-140-BL
48"	SB3548-140-BL
30"	SB3530-140-BR
36"	SB3536-140-BR
42"	SB3542-140-BR
48"	SB3548-140-BR



Right-hinged door shown

Width	Left & Right Hinged
30"	SB3530-134L
36"	SB3536-134L
42"	SB3542-134L
48"	SB3548-134L
30"	SB3530-134R
36"	SB3536-134R
42"	SB3542-134R
48"	SB3548-134R



Right-hinged door shown

Width	Left & Right Hinged
30"	SB3530-134-AL
36"	SB3536-134-AL
42"	SB3542-134-AL
48"	SB3548-134-AL
30"	SB3530-134-AR
36"	SB3536-134-AR
42"	SB3542-134-AR
48"	SB3548-134-AR



30" and wider

Width	Item Number
30"	SB3530-210
36"	SB3536-210
42"	SB3542-210
48"	SB3548-210



Right-hinged door shown

Width	Left & Right Hinged
30"	SB3530-210-AL
36"	SB3536-210-AL
42"	SB3542-210-AL
48"	SB3548-210-AL
30"	SB3530-210-AR
36"	SB3536-210-AR
42"	SB3542-210-AR
48"	SB3548-210-AR

Base Cabinets — Standing Height

Standing height base cabinets are 34.75" high and 22.375" deep. Units are available in various widths as shown. Drawer units feature 100 lb. full extension slides as standard. Door units feature a single shelf as standard. Additional shelves are available. Specify left- or right-hinged doors using the suffix "L" or "R". If locks are required use the suffix "LK". If vertical divider is required between cup board and drawer section use the suffix "VD". If finished Back is required use the suffix "FB".

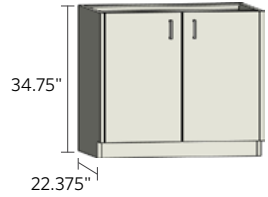

DOOR & DRAWER CABINETS



Right-hinged door shown

Width	Left & Right Hinged
30"	SB3530-150L
36"	SB3536-150L
42"	SB3542-150L
48"	SB3548-150L
30"	SB3530-150R
36"	SB3536-150R
42"	SB3542-150R
48"	SB3548-150R



Right-hinged door shown

Width	Left & Right Hinged
30"	SB3530-116L
36"	SB3536-116L
42"	SB3542-116L
48"	SB3548-116L
30"	SB3530-116R
36"	SB3536-116R
42"	SB3542-116R
48"	SB3548-116R



Right-hinged door shown

Width	Left & Right Hinged
30"	SB3530-126L
36"	SB3536-126L
42"	SB3542-126L
48"	SB3548-126L
30"	SB3530-126R
36"	SB3536-126R
42"	SB3542-126R
48"	SB3548-126R



Right-hinged door shown

Width	Left & Right Hinged
30"	SB3530-126-AL
36"	SB3536-126-AL
42"	SB3542-126-AL
48"	SB3548-126-AL
30"	SB3530-126-AR
36"	SB3536-126-AR
42"	SB3542-126-AR
48"	SB3548-126-AR



Right-hinged door shown

Width	Left & Right Hinged
30"	SB3530-108L
36"	SB3536-108L
42"	SB3542-108L
48"	SB3548-108L
30"	SB3530-108R
36"	SB3536-108R
42"	SB3542-108R
48"	SB3548-108R



Right-hinged door shown

Width	Left & Right Hinged
30"	SB3530-132L
36"	SB3536-132L
42"	SB3542-132L
48"	SB3548-132L
30"	SB3530-132R
36"	SB3536-132R
42"	SB3542-132R
48"	SB3548-132R

Base Cabinets — Standing Height

Standing height base cabinets are 34.75" high and 22.375" deep. Units are available in various widths as shown. Drawer units feature 100 lb. full extension slides as standard. Door units feature a single shelf as standard. Additional shelves are available. Specify left- or right-hinged doors using the suffix "L" or "R". If locks are required use the suffix "LK". If finished Back is required use the suffix "FB".

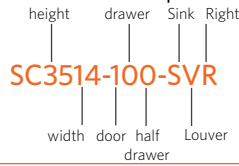
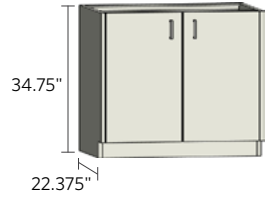

SHELVES & PULL OUT SHELVES

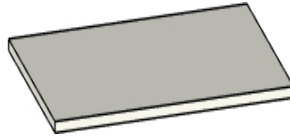
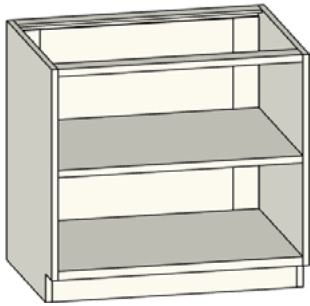

Width	Item Number
12"	SBS1222
15"	SBS1522
18"	SBS1822
21"	SBS2122
24"	SBS2422
30"	SBS3022
36"	SBS3622
42"	SBS4222
48"	SBS4822

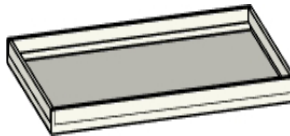
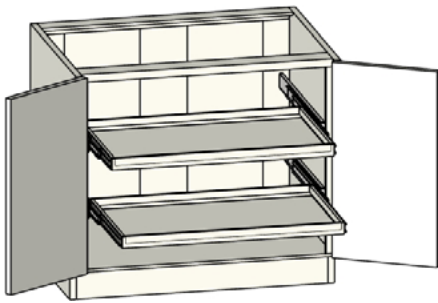

Width	Item Number
15"	SBPOS-1522
18"	SBPOS-1822
21"	SBPOS-2122
24"	SBPOS-2422
30"	SBPOS-3022
36"	SBPOS-3622
42"	SBPOS-4222
48"	SBPOS-4822

CORNER CABINETS

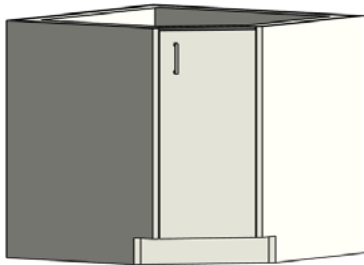

Right-hinged door shown

Left hinged	Right hinged
SC3514-100L	SC3514-100R

Lazy Susan Add-On Suffix
 "LS"

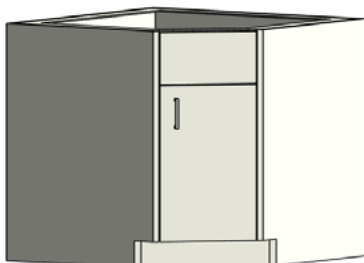

Right-hinged door shown

Left hinged	Right hinged
SC3514-100-SL	SC3514-100-SR

Left hinged with louvers	Right hinged with louvers
SC3514-100-SVL	SC3514-100-SVR

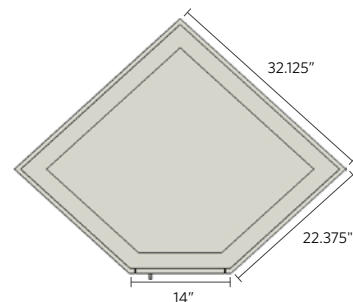

Base Cabinets — Standing Height

Standing height base cabinets are 34.75" high and 22.375" deep. Units are available in various widths as shown. Drawer units feature 100 lb. full extension slides as standard. Door units feature a single shelf as standard. Additional shelves are available. Specify left- or right-hinged doors using the suffix "L" or "R". If locks are required use the suffix "LK". If finished Back is required use the suffix "FB".

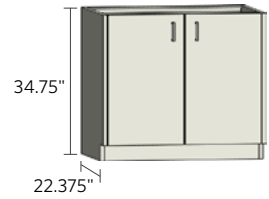

THREE OR FIVE EQUAL DRAWER CABINETS



Up to 24" wide

Width	Item Number
12"	SB3512-03X
15"	SB3515-03X
18"	SB3518-03X
21"	SB3521-03X
24"	SB3524-03X



30" and wider

Width	Item Number
30"	SB3530-03X
36"	SB3536-03X
42"	SB3542-03X
48"	SB3548-03X



Up to 24" wide

Width	Item Number
12"	SB3512-05X
15"	SB3515-05X
18"	SB3518-05X
21"	SB3521-05X
24"	SB3524-05X



30" and wider

Width	Item Number
30"	SB3530-05X
36"	SB3536-05X
42"	SB3542-05X
48"	SB3548-05X



30" and wider

Width	Item Number
30"	SB3530-0(10)X
36"	SB3536-0(10)X
42"	SB3542-0(10)X
48"	SB3548-0(10)X



Right-hinged door shown

Width	Left & Right Hinged
30"	SB3530-15X-L
36"	SB3536-15X-L
42"	SB3542-15X-L
48"	SB3548-15X-L
30"	SB3530-15X-R
36"	SB3536-15X-R
42"	SB3542-15X-R
48"	SB3548-15X-R

Base Cabinets — Standing Height

Standing height base cabinets are 34.75" high and 22.375" deep. Units are available in various widths as shown. Drawer units feature 100 lb. full extension slides as standard. Specify left- or right-hinged doors using the suffix "L" or "R". If locks are required use the suffix "LK". If finished Back is required use the suffix "FB".

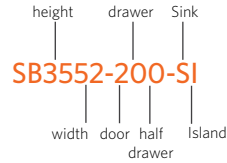
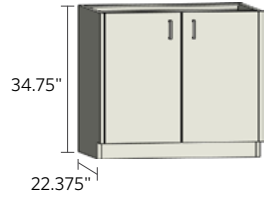

SINK & FUME HOOD CABINETS

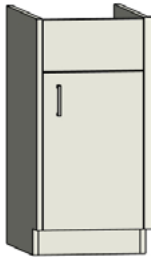

Right-hinged door shown

Width	Left & Right Hinged
12"	SB3512-100-SL
15"	SB3515-100-SL
18"	SB3518-100-SL
21"	SB3521-100-SL
24"	SB3524-100-SL
12"	SB3512-100-SR
15"	SB3515-100-SR
18"	SB3518-100-SR
21"	SB3521-100-SR
24"	SB3524-100-SR

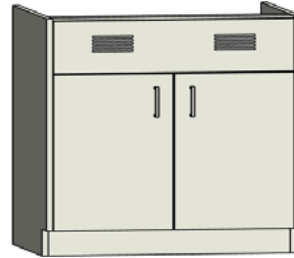

30" and wider

Width	Item Number
30"	SB3530-200-SV
36"	SB3536-200-SV
42"	SB3542-200-SV
48"	SB3548-200-SV
52"	SB3552-200-SV
58"	SB3558-200-SV

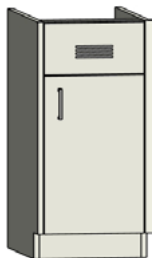

Right-hinged door shown

Width	Left & Right Hinged
12"	SB3512-100-SVL
15"	SB3515-100-SVL
18"	SB3518-100-SVL
21"	SB3521-100-SVL
24"	SB3524-100-SVL
12"	SB3512-100-SVR
15"	SB3515-100-SVR
18"	SB3518-100-SVR
21"	SB3521-100-SVR
24"	SB3524-100-SVR

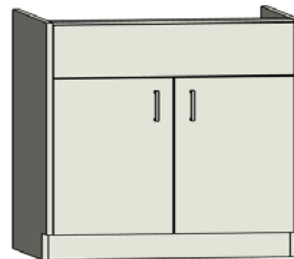

30" and wider

Width	Item Number
30"	SB3530-200-S
36"	SB3536-200-S
42"	SB3542-200-S
48"	SB3548-200-S

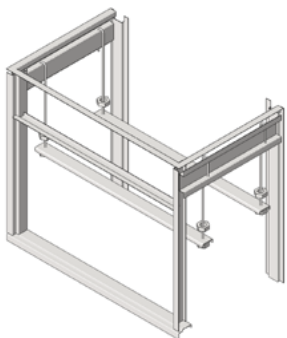

Sink Support Assembly

Item Number
SS-C14
SS-18
SS-24
SS-30
SS-36
SS-42
SS-48
SS-52
SS-58

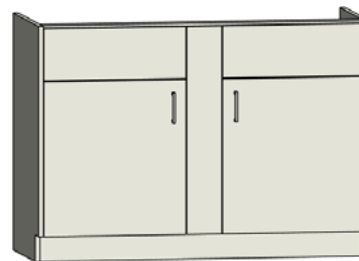

Width	Item Number
52"	SB3552-200-S
58"	SB3558-200-S

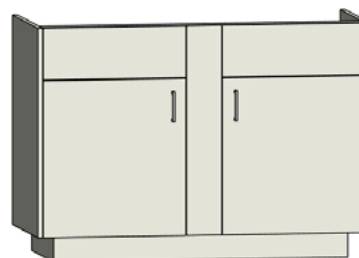

Width	Item Number
52"	SB3552-200-SI
58"	SB3558-200-SI

Base Cabinets — Sitting Height

Sitting height cabinets are 28.75" high and 22.375" deep. Units are available in various widths as shown. Door units feature single shelf as standard. Additional shelves are available. Specify left- or right-hinged doors using the suffix "L" or "R". If locks are required, use the suffix "LK". If finished Back is required use the suffix "FB".

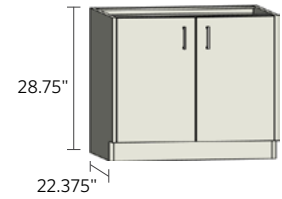

OPEN CABINETS

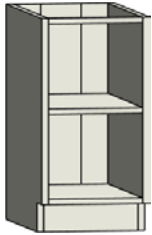

Up to 24" wide

Width	Item Number
12"	SB2912-000
15"	SB2915-000
18"	SB2918-000
21"	SB2921-000
24"	SB2924-000

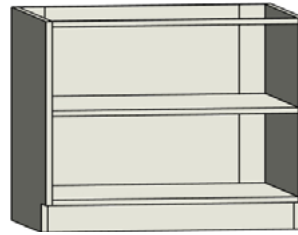

30" and wider

Width	Item Number
30"	SB2930-000
36"	SB2936-000
42"	SB2942-000
48"	SB2948-000

DOOR CABINETS

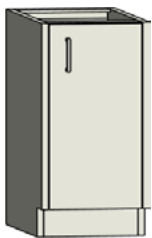

Right-hinged door shown

Width	Left & Right Hinged
12"	SB2912-100L
15"	SB2915-100L
18"	SB2918-100L
21"	SB2921-100L
24"	SB2924-100L
12"	SB2912-100R
15"	SB2915-100R
18"	SB2918-100R
21"	SB2921-100R
24"	SB2924-100R

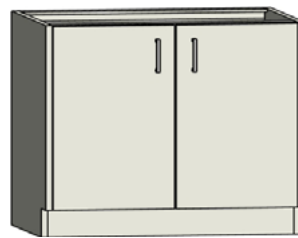

30" and wider

Width	Item Number
30"	SB2930-200
36"	SB2936-200
42"	SB2942-200
48"	SB2948-200



Example: SB2930-100-LPNL

Width	Left & Right Hinged
30"	SB2930-100-LPNL
36"	SB2936-100-LPNL
42"	SB2942-100-LPNL
48"	SB2948-100-LPNL
30"	SB2930-100-RPNL
36"	SB2936-100-RPNL
42"	SB2942-100-RPNL
48"	SB2948-100-RPNL

Note: L(left) or R(right) refers to door hinge side.
PNL(panel) refers to panel next to door.

Base Cabinets — Sitting Height

Sitting height cabinets are 28.75" high and 22.375" deep. Units are available in various widths as shown. Drawer units feature 100 lb. full extension slides as standard. If locks are required, use the suffix "LK". If finished Back is required use the suffix "FB".

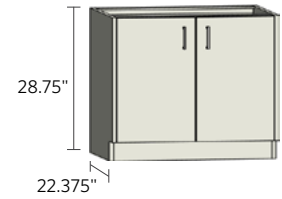

DRAWER CABINETS



Up to 24" wide

Width	Item Number
12"	SB2912-030
15"	SB2915-030
18"	SB2918-030
21"	SB2921-030
24"	SB2924-030



30" and wider

Width	Item Number
30"	SB2930-030
36"	SB2936-030
42"	SB2942-030
48"	SB2948-030



Up to 24" wide

Width	Item Number
12"	SB2912-022
15"	SB2915-022
18"	SB2918-022
21"	SB2921-022
24"	SB2924-022



30" and wider

Width	Item Number
30"	SB2930-022
36"	SB2936-022
42"	SB2942-022
48"	SB2948-022



Up to 24" wide

Width	Item Number
12"	SB2912-014
15"	SB2915-014
18"	SB2918-014
21"	SB2921-014
24"	SB2924-014



30" and wider

Width	Item Number
30"	SB2930-014
36"	SB2936-014
42"	SB2942-014
48"	SB2948-014

Base Cabinets — Sitting Height

Sitting height cabinets are 28.75" high and 22.375" deep. Units are available in various widths as shown. Drawer units feature 100 lb. full extension slides as standard. If locks are required, use the suffix "LK". If finished Back is required use the suffix "FB".

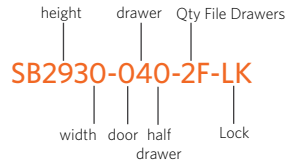
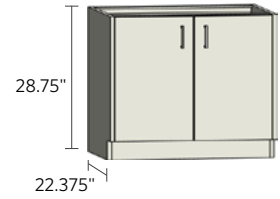

DRAWER CABINETS



Up to 24" wide

Width	Item Number
12"	SB2912-006
15"	SB2915-006
18"	SB2918-006
21"	SB2921-006
24"	SB2924-006



30" and wider

Width	Item Number
30"	SB2930-006
36"	SB2936-006
42"	SB2942-006
48"	SB2948-006



Up to 24" wide

Width	Item Number
12"	SB2912-002-1F
15"	SB2915-002-1F
18"	SB2918-002-1F
21"	SB2921-002-1F
24"	SB2924-002-1F



30" and wider

Width	Item Number
30"	SB2930-004-2F
36"	SB2936-004-2F
42"	SB2942-004-2F
48"	SB2948-004-2F



Up to 24" wide

Width	Item Number
15"	SB2915-000-2F
18"	SB2918-000-2F
21"	SB2921-000-2F
24"	SB2924-000-2F



30" and wider

Width	Item Number
30"	SB2930-000-4F
36"	SB2936-000-4F
42"	SB2942-000-4F
48"	SB2948-000-4F



Up to 24" wide

Width	Item Number
15"	SB2915-010-1F
18"	SB2918-010-1F
21"	SB2921-010-1F
24"	SB2924-010-1F



30" and wider

Width	Item Number
30"	SB2930-020-2F
36"	SB2936-020-2F
42"	SB2942-020-2F
48"	SB2948-020-2F

Base Cabinets — Sitting Height

Sitting height cabinets are 28.75" high and 22.375" deep. Units are available in various widths as shown. Drawer units feature 100 lb. full extension slides as standard. If locks are required, use the suffix "LK". If finished Back is required use the suffix "FB".

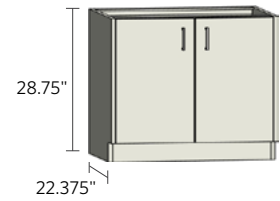

DRAWER CABINETS



30" and wider

Width	Item Number
30"	SB2930-060
36"	SB2936-060
42"	SB2942-060
48"	SB2948-060



30" and wider

Width	Item Number
30"	SB2930-044
36"	SB2936-044
42"	SB2942-044
48"	SB2948-044



30" and wider

Width	Item Number
30"	SB2930-040
36"	SB2936-040
42"	SB2942-040
48"	SB2948-040



30" and wider

Width	Item Number
30"	SB2930-028
36"	SB2936-028
42"	SB2942-028
48"	SB2948-028

Base Cabinets — Sitting Height

Sitting height cabinets are 28.75" high and 22.375" deep. Units are available in various widths as shown. No shelves are available in sitting height base cabinets with the combination of doors and drawers. Drawer units feature 100 lb. full extension slides as standard. Specify left or right-hinged doors using the suffix "L" or "R". If locks are required, use the suffix "LK". If finished Back is required use the suffix "FB".

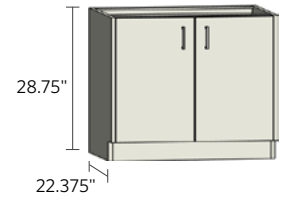

DOOR & DRAWER CABINETS



Right-hinged door shown

Width	Left & Right Hinged
12"	SB2912-110L
15"	SB2915-110L
18"	SB2918-110L
21"	SB2921-110L
24"	SB2924-110L
12"	SB2912-110R
15"	SB2915-110R
18"	SB2918-110R
21"	SB2921-110R
24"	SB2924-110R



Right-hinged door shown

Width	Left & Right Hinged
12"	SB2912-102L
15"	SB2915-102L
18"	SB2918-102L
21"	SB2921-102L
24"	SB2924-102L
12"	SB2912-102R
15"	SB2915-102R
18"	SB2918-102R
21"	SB2921-102R
24"	SB2924-102R



30" and wider

Width	Item Number
30"	SB2930-220
36"	SB2936-220
42"	SB2942-220
48"	SB2948-220



30" and wider

Width	Item Number
30"	SB2930-212
36"	SB2936-212
42"	SB2942-212
48"	SB2948-212



30" and wider

Width	Item Number
30"	SB2930-204
36"	SB2936-204
42"	SB2942-204
48"	SB2948-204



Right-hinged door shown

Width	Left & Right Hinged
30"	SB2930-132L
36"	SB2936-132L
42"	SB2942-132L
48"	SB2948-132L
30"	SB2930-132R
36"	SB2936-132R
42"	SB2942-132R
48"	SB2948-132R

Base Cabinets — Sitting Height

Sitting height cabinets are 28.75" high and 22.375" deep. Units are available in various widths as shown. No shelves are available in sitting height base cabinets with the combination of doors and drawers. Drawer units feature 100 lb. full extension slides as standard. Door units feature single shelf as standard. Additional shelves are available. Specify left- or right-hinged doors using the suffix "L" or "R". If locks are required, use the

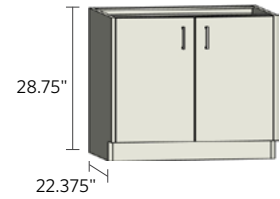

DOOR & DRAWER CABINETS



30" and wider

Width	Item Number
30"	SB2930-210
36"	SB2936-210
42"	SB2942-210
48"	SB2948-210



Right-hinged door shown

Width	Left & Right Hinged
30"	SB2930-210-AL
36"	SB2936-210-AL
42"	SB2942-210-AL
48"	SB2948-210-AL
30"	SB2930-210-AR
36"	SB2936-210-AR
42"	SB2942-210-AR
48"	SB2948-210-AR



30" and wider

Width	Item Number
30"	SB2930-202
36"	SB2936-202
42"	SB2942-202
48"	SB2948-202



Right-hinged door shown

Width	Left & Right Hinged
30"	SB2930-202-AL
36"	SB2936-202-AL
42"	SB2942-202-AL
48"	SB2948-202-AL
30"	SB2930-202-AR
36"	SB2936-202-AR
42"	SB2942-202-AR
48"	SB2948-202-AR



Right-hinged door shown

Width	Left & Right Hinged
30"	SB2930-130L
36"	SB2936-130L
42"	SB2942-130L
48"	SB2948-130L
30"	SB2930-130R
36"	SB2936-130R
42"	SB2942-130R
48"	SB2948-130R



Right-hinged door shown

Width	Left & Right Hinged
30"	SB2930-130-AL
36"	SB2936-130-AL
42"	SB2942-130-AL
48"	SB2948-130-AL
30"	SB2930-130-AR
36"	SB2936-130-AR
42"	SB2942-130-AR
48"	SB2948-130-AR

Base Cabinets — Sitting Height

Sitting height cabinets are 28.75" high and 22.375" deep. Units are available in various widths as shown. No shelves are available in sitting height base cabinets with the combination of doors and drawers. Drawer units feature 100 lb. full extension slides as standard. Door units feature single shelf as standard. Additional shelves are available. Specify left- or right-hinged doors using the suffix "L" or "R". If locks are required, use the suffix "LK". If vertical divider is required between cup board and drawer section use the suffix "VD". If finished Back is required use the suffix "FB".

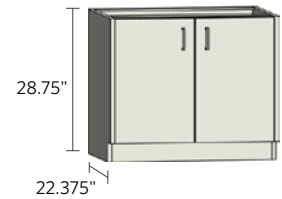

DOOR & DRAWER CABINETS



Right-hinged door shown

Width	Left & Right Hinged
30"	SB2930-116L
36"	SB2936-116L
42"	SB2942-116L
48"	SB2948-116L
30"	SB2930-116R
36"	SB2936-116R
42"	SB2942-116R
48"	SB2948-116R



Right-hinged door shown

Width	Left & Right Hinged
30"	SB2930-116-AL
36"	SB2936-116-AL
42"	SB2942-116-AL
48"	SB2948-116-AL
30"	SB2930-116-AR
36"	SB2936-116-AR
42"	SB2942-116-AR
48"	SB2948-116-AR



Right-hinged door shown

Width	Left & Right Hinged
30"	SB2930-124L
36"	SB2936-124L
42"	SB2942-124L
48"	SB2948-124L
30"	SB2930-124R
36"	SB2936-124R
42"	SB2942-124R
48"	SB2948-124R



Right-hinged door shown

Width	Left & Right Hinged
30"	SB2930-124-AL
36"	SB2936-124-AL
42"	SB2942-124-AL
48"	SB2948-124-AL
30"	SB2930-124-AR
36"	SB2936-124-AR
42"	SB2942-124-AR
48"	SB2948-124-AR



Right-hinged door shown

Width	Left & Right Hinged
30"	SB2930-114L
36"	SB2936-114L
42"	SB2942-114L
48"	SB2948-114L
30"	SB2930-114R
36"	SB2936-114R
42"	SB2942-114R
48"	SB2948-114R



Right-hinged door shown

Width	Left & Right Hinged
30"	SB2930-108L
36"	SB2936-108L
42"	SB2942-108L
48"	SB2948-108L
30"	SB2930-108R
36"	SB2936-108R
42"	SB2942-108R
48"	SB2948-108R

SINK & FUME HOOD CABINETS



Right-hinged door shown

Width	Left hinged	Right hinged
12"	SB2912-100-SL	SB2912-100-SR
15"	SB2915-100-SL	SB2915-100-SR
18"	SB2918-100-SL	SB2918-100-SR
21"	SB2921-100-SL	SB2921-100-SR
24"	SB2924-100-SL	SB2924-100-SR

Width	Left hinged with louvers	Right hinged with louvers
12"	SB2912-100-SVL	SB2912-100-SVR
15"	SB2915-100-SVL	SB2915-100-SVR
18"	SB2918-100-SVL	SB2918-100-SVR
21"	SB2921-100-SVL	SB2921-100-SVR
24"	SB2924-100-SVL	SB2924-100-SVR

Base Cabinets — Sitting Height

Sitting height cabinets are 28.75" high and 22.375" deep. Units are available in various widths as shown. Drawer units feature 100 lb. full extension slides as standard. Full height door units feature single shelf as standard. Additional shelves are available. Specify left- or right-hinged doors using the suffix "L" or "R". If locks are required, use the suffix "LK". If finished Back is required use the suffix "FB".

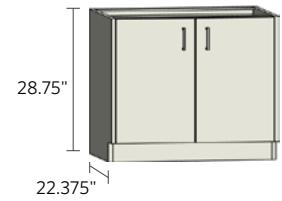

SINK & FUME HOOD CABINETS

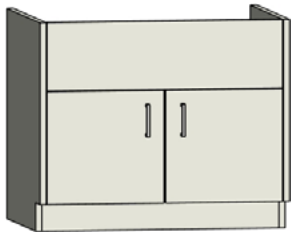

Width	Item Number
30"	SB2930-200-S
36"	SB2936-200-S
42"	SB2942-200-S
48"	SB2948-200-S

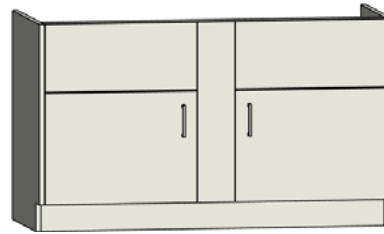

Width	Item Number
52"	SB2952-200-S
58"	SB2958-200-S

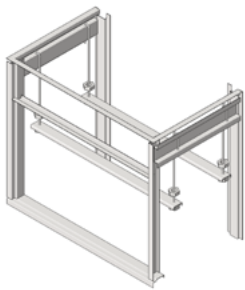

Sink Support Assembly

Item Number
SS-C14
SS-18
SS-24
SS-30
SS-36
SS-42
SS-48
SS-52
SS-58

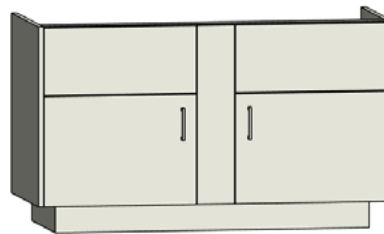

Width	Item Number
52"	SB2952-200-SI
58"	SB2958-200-SI

CORNER CABINETS

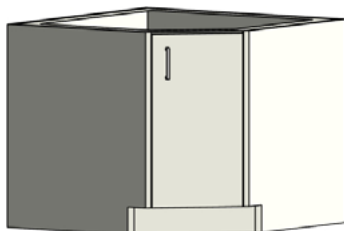

Right-hinged door shown

Item Number
Left & Right Hinged
SC2914-100L
SC2914-100R

Lazy Susan Add-On Suffix
"LS"

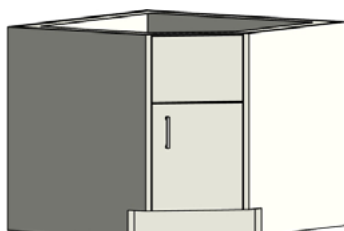

Right-hinged door shown

Left hinged	Right hinged
SC2914-100-SL	SC2914-100-SR

Left hinged with louvers	Right hinged with louvers
SC2914-100-SVL	SC2914-100-SVR

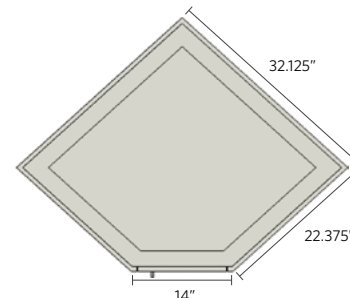

Base Cabinets — ADA Height

ADA height cabinets are 31.75" high and 22.375" deep. Units are available in various widths as shown. Door units feature single shelf as standard. Additional shelves are available. Specify left- or right-hinged doors using the suffix "L" or "R". If locks are required, use the suffix "LK". If finished Back is required use the suffix "FB".

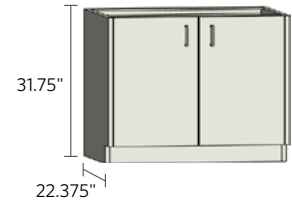

OPEN CABINETS

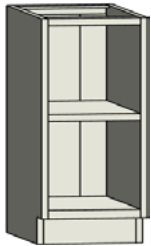

Up to 24" wide

Width	Item Number
12"	SB3212-000
15"	SB3215-000
18"	SB3218-000
21"	SB3221-000
24"	SB3224-000

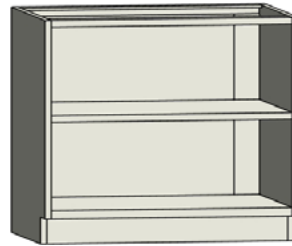

30" and wider

Width	Item Number
30"	SB3230-000
36"	SB3236-000
42"	SB3242-000
48"	SB3248-000

DOOR CABINETS

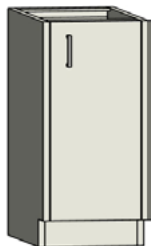

Right-hinged door shown

Width	Left & Right Hinged
12"	SB3212-100L
15"	SB3215-100L
18"	SB3218-100L
21"	SB3221-100L
24"	SB3224-100L
12"	SB3212-100R
15"	SB3215-100R
18"	SB3218-100R
21"	SB3221-100R
24"	SB3224-100R



30" and wider

Width	Item Number
30"	SB3230-200
36"	SB3236-200
42"	SB3242-200
48"	SB3248-200

Base Cabinets — ADA Height

ADA height cabinets are 31.75" high and 22.375" deep. Units are available in various widths as shown. Full height door units feature single shelf as standard. Additional shelves are available. Drawer units feature 100 lb. full extension slides as standard. If locks are required, use the suffix "LK". If finished Back is required use the suffix "FB".

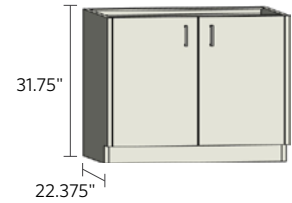

DRAWER CABINETS



12" and wider

Width	Item Number
12"	SB3212-031
15"	SB3215-031
18"	SB3218-031
21"	SB3221-031
24"	SB3224-031



30" and wider

Width	Item Number
30"	SB3230-031
36"	SB3236-031
42"	SB3242-031
48"	SB3248-031



Up to 24" wide

Width	Item Number
12"	SB3212-020-1F
15"	SB3215-020-1F
18"	SB3218-020-1F
21"	SB3221-020-1F
24"	SB3224-020-1F



30" and wider

Width	Item Number
30"	SB3230-040-2F
36"	SB3236-040-2F
42"	SB3242-040-2F
48"	SB3248-040-2F



Up to 24" wide

Width	Item Number
15"	SB3215-012-1F
18"	SB3218-012-1F
21"	SB3221-012-1F
24"	SB3224-012-1F



30" and wider

Width	Item Number
30"	SB3230-024-2F
36"	SB3236-024-2F
42"	SB3242-024-2F
48"	SB3248-024-2F



30" and wider

Width	Item Number
30"	SB3230-062
36"	SB3236-062
42"	SB3242-062
48"	SB3248-062

Base Cabinets — ADA Height

ADA height cabinets are 31.75" high and 22.375" deep. Units are available in various widths as shown. Drawer units feature 100 lb. full extension slides as standard. Full height door units feature single shelf as standard. Additional shelves are available. Specify left- or right-hinged doors using the suffix "L" or "R". If locks are required, use the suffix "LK". If finished Back is required use the suffix "FB".

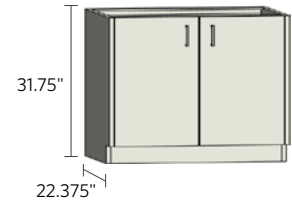

DOOR & DRAWER CABINETS

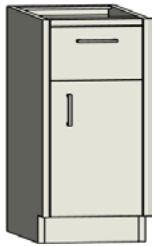

Right-hinged door shown

Width	Left & Right Hinged
12"	SB3212-110L
15"	SB3215-110L
18"	SB3218-110L
21"	SB3221-110L
24"	SB3224-110L
12"	SB3212-110R
15"	SB3215-110R
18"	SB3218-110R
21"	SB3221-110R
24"	SB3224-110R



30" and wider

Width	Item Number
30"	SB3230-202-A
36"	SB3236-202-A
42"	SB3242-202-A
48"	SB3248-202-A



30" and wider

Width	Item Number
30"	SB3230-210
36"	SB3236-210
42"	SB3242-210
48"	SB3248-210



30" and wider

Width	Item Number
30"	SB3230-201
36"	SB3236-201
42"	SB3242-201
48"	SB3248-201



30" and wider

Width	Item Number
30"	SB3230-220
36"	SB3236-220
42"	SB3242-220
48"	SB3248-220



30" and wider

Width	Item Number
30"	SB3230-202
36"	SB3236-202
42"	SB3242-202
48"	SB3248-202

Base Cabinets — ADA Height

ADA height cabinets are 31.75" high and 22.375" deep. Units are available in various widths as shown. Drawer units feature 100 lb. full extension slides as standard. Door units feature single shelf as standard. Additional shelves are available. Specify left- or right-hinged doors using the suffix "L" or "R". If locks are required, use the suffix "LK". If finished Back is required use the suffix "FB".

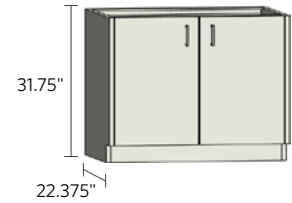

CORNER CABINETS

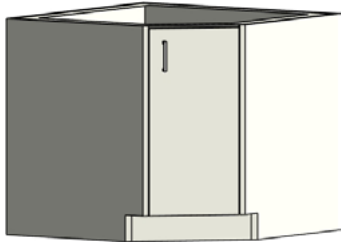

Right-hinged door shown

Left hinged	Right hinged
SC3214-100L-LS	SC3214-100R-LS

Lazy Susan Add-On Suffix
"LS"

Left hinged	Right hinged
SC3214-100L	SC3214-100R

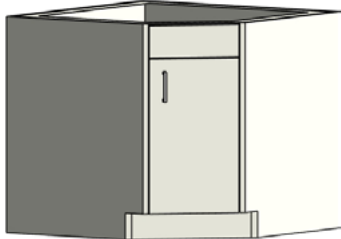

Right-hinged door shown

Left hinged	Right hinged
SC3214-100-SL	SC3214-100-SR

Left hinged with louvers	Right hinged with louvers
SC3214-100-SVL	SC3214-100-SVR

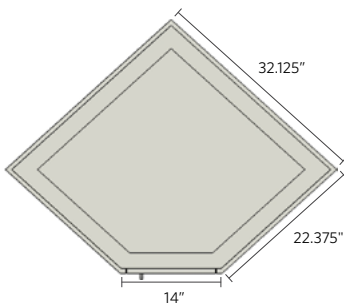

Base Cabinets — ADA Height

ADA height cabinets are 31.75" high and 22.375" deep. Units are available in various widths as shown. Full height door units feature single shelf as standard. Additional shelves are available. Specify left- or right-hinged doors using the suffix "L" or "R". If locks are required, use the suffix "LK". If finished Back is required use the suffix "FB".

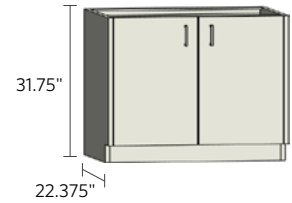

SINK & FUME HOOD CABINETS

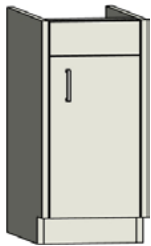

Right-hinged door shown

Width	Left & Right Hinged
12"	SB3212-100-SL
15"	SB3215-100-SL
18"	SB3218-100-SL
21"	SB3221-100-SL
24"	SB3224-100-SL
12"	SB3224-100-SR
15"	SB3224-100-SR
18"	SB3224-100-SR
21"	SB3221-100-SR
24"	SB3224-100-SR

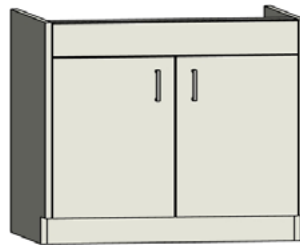

Width	Item Number
30"	SB3230-200-S
36"	SB3236-200-S
42"	SB3242-200-S
48"	SB3248-200-S

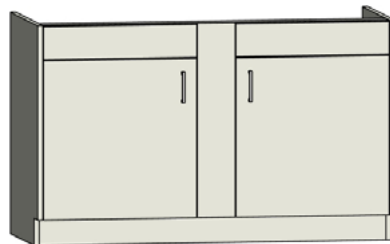

Width	Item Number
52"	SB3252-200-S
58"	SB3258-200-S

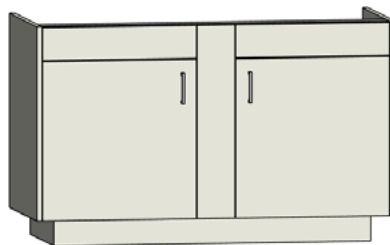

Width	Item Number
52"	SB3252-200-SI
58"	SB3258-200-SI

Base Cabinets — ADA Height

ADA height cabinets are 31.75" high and 22.375" deep. Units are available in various widths as shown. Drawer units feature 100 lb. full extension slides as standard. Door units feature single shelf as standard. Additional shelves are available. Specify left- or right-hinged doors using the suffix "L" or "R". If locks are required, use the suffix "LK". If finished Back is required use the suffix "FB".

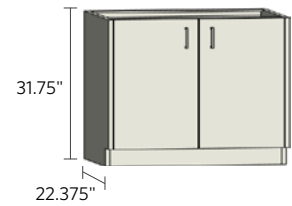

SINK & FUME HOOD CABINETS

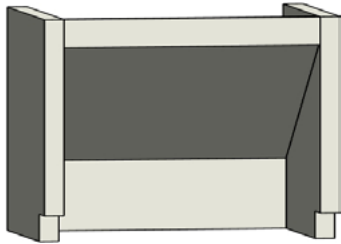

Width	Item Number
36"	SADAKSC36
42"	SADAKSC42
48"	SADAKSC48

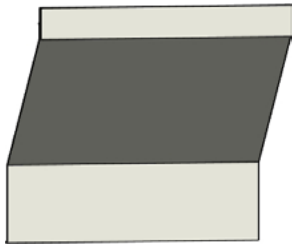

Width	Item Number
30"	SADAKSP30
36"	SADAKSP36
42"	SADAKSP42
48"	SADAKSP48

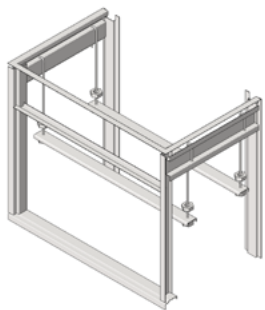

Sink Support Assembly

Item Number
SS-C14
SS-18
SS-24
SS-30
SS-36
SS-42
SS-48
SS-52
SS-58

Base Cabinets — Corrosives

Corrosives storage cabinets are reinforced steel with a hi-tech performance polymer alloy coating, which provides 100% coverage against corrosion. Cabinets are available in 18" and 22" depths.

Example:

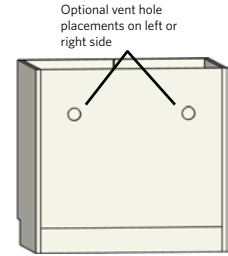

CORROSIVES STORAGE CABINETS

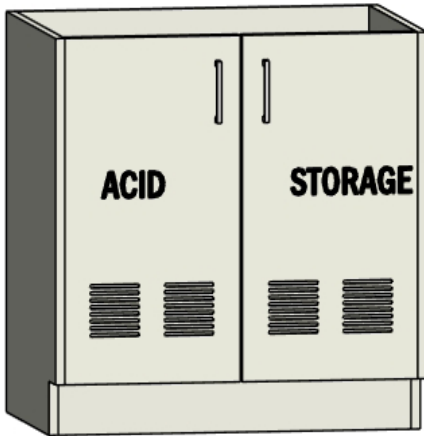

Width	Sitting Height	ADA Height	Standing Height
18"	SASB2918-18	SASB3218-18	SASB3518-18
24"	SASB2924-18	SASB3224-18	SASB3524-18
30"	SASB2930-18	SASB3230-18	SASB3530-18
36"	SASB2936-18	SASB3236-18	SASB3536-18
42"	SASB2942-18	SASB3242-18	SASB3542-18
48"	SASB2948-18	SASB3248-18	SASB3548-18
52"	SASB2952-18	SASB3252-18	SASB3552-18
58"	SASB2958-18	SASB3258-18	SASB3558-18

Width	Sitting Height	ADA Height	Standing Height
18"	SASB2918-22	SASB3218-22	SASB3518-22
24"	SASB2924-22	SASB3224-22	SASB3524-22
30"	SASB2930-22	SASB3230-22	SASB3530-22
36"	SASB2936-22	SASB3236-22	SASB3536-22
42"	SASB2942-22	SASB3242-22	SASB3542-22
48"	SASB2948-22	SASB3248-22	SASB3548-22
52"	SASB2952-22	SASB3252-22	SASB3552-22
58"	SASB2958-22	SASB3258-22	SASB3558-22

When ordering 18" or 24" wide cabinets please place suffix "L" left or "R" right, after the part number for the hinge placement.

If a Vent Kit is required, use the suffix "VK".

Note: AMS recommends vent kits for all corrosives cabinets. Acids and bases should not be stored in the same cabinet.

Base Cabinets — Flammables

Flammable storage cabinets are reinforced steel with a hi-tech performance polymer alloy coating, which provides 100% coverage against corrosion. Cabinets are available in 18" and 22" depths.

Example:

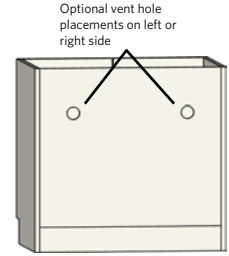

FLAMMABLES STORAGE CABINETS



Width	Sitting Height	ADA Height	Standing Height
18"	SFSB2918-18	SFSB3218-18	SFSB3518-18
24"	SFSB2924-18	SFSB3224-18	SFSB3524-18
30"	SFSB2930-18	SFSB3230-18	SFSB3530-18
36"	SFSB2936-18	SFSB3236-18	SFSB3536-18
42"	SFSB2942-18	SFSB3242-18	SFSB3542-18
48"	SFSB2948-18	SFSB3248-18	SFSB3548-18
52"	SFSB2952-18	SFSB3252-18	SFSB3552-18
58"	SFSB2958-18	SFSB3258-18	SFSB3558-18

Width	Sitting Height	ADA Height	Standing Height
18"	SFSB2918-22	SFSB3218-22	SFSB3518-22
24"	SFSB2924-22	SFSB3224-22	SFSB3524-22
30"	SFSB2930-22	SFSB3230-22	SFSB3530-22
36"	SFSB2936-22	SFSB3236-22	SFSB3536-22
42"	SFSB2942-22	SFSB3242-22	SFSB3542-22
48"	SFSB2948-22	SFSB3248-22	SFSB3548-22
52"	SFSB2952-22	SFSB3252-22	SFSB3552-22
58"	SFSB2958-22	SFSB3258-22	SFSB3558-22

Mobile cabinets are available. Please contact your AMS representative.

Flammables storage cabinets are certified to meet NFPA 45 and are UL listed. Cabinets are available in 18" and 22" depths. For 22" depth, add suffix "-22" to the part number. For synchronized self-closing doors add "-SCC" to the part number.

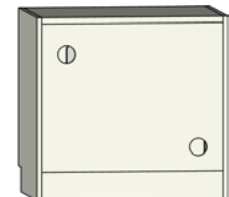

Vacuum Pump Cabinets

Vacuum Pump Cabinets come with a Polydamp Melamine Foam that has heat resistance and sound dampening qualities. This is applied to the inside of the cabinet. (Please note actual cabinet depth with finished back will be 22.875" and 18.875").

Vent pipe as shown is not included



Vent pipe as shown is not included

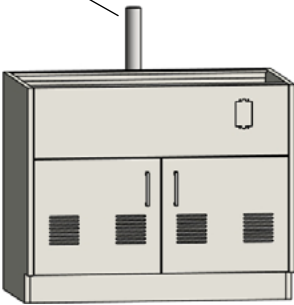

Vent pipe as shown is not included

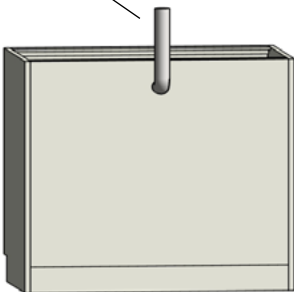

Vent pipe as shown is not included

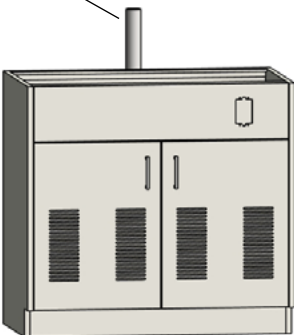

Width	Item Number
15"	SB3515-10V
18"	SB3518-10V
21"	SB3521-10V
24"	SB3524-10V

When ordering 18" or 24" wide cabinets please place suffix "L" left or "R" right, after the part number for the hinge placement.

Attention: All of these units are shipped with a loose unassembled junction box, switch and wiring. These are to be installed by your certified electrician.

Width	Item Number
30"	SB2930-20V-18
36"	SB2936-20V-18
42"	SB2942-20V-18
48"	SB2948-20V-18

Width	Item Number
30"	SB2930-20V
36"	SB2936-20V
42"	SB2942-20V
48"	SB2948-20V

Width	Item Number
30"	SB3230-20V-18
36"	SB3236-20V-18
42"	SB3242-20V-18
48"	SB3248-20V-18

Width	Item Number
30"	SB3230-20V
36"	SB3236-20V
42"	SB3242-20V
48"	SB3248-20V

Width	Item Number
30"	SB3530-20V-18
36"	SB3536-20V-18
42"	SB3542-20V-18
48"	SB3548-20V-18

Width	Item Number
30"	SB3530-20V
36"	SB3536-20V
42"	SB3542-20V
48"	SB3548-20V

Vacuum Pump Cabinets

Vacuum Pump Cabinets come with a Polydamp Melamine Foam that has heat resistance and sound dampening qualities. This is applied to the inside of the cabinet. (Please note actual cabinet depth with finished back will be 22.875" and 18.875").

Vent pipe as shown is not included

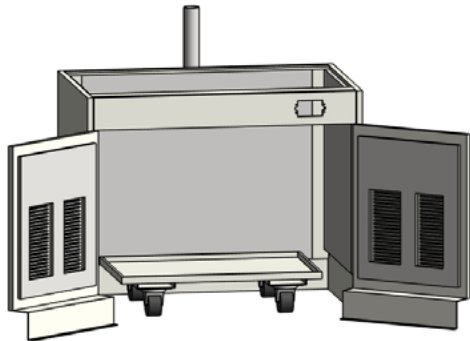
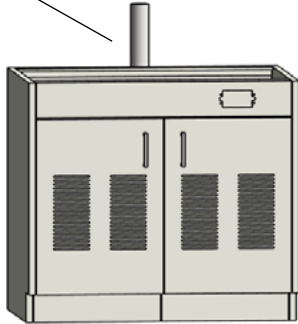

Attention: These units are shipped with a loose unassembled junction box, switch and wiring. These are to be installed by your certified electrician.

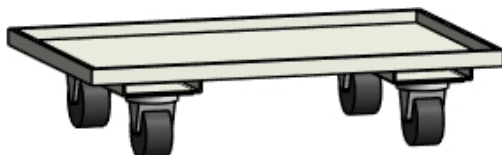

These units include the cart pictured as part of the unit price. Vent pipe is not included.

Width	Item Number
30"	SB2930-20V-18-NB
36"	SB2936-20V-18-NB
42"	SB2942-20V-18-NB
48"	SB2948-20V-18-NB

Width	Item Number
30"	SB2930-20V-NB
36"	SB2936-20V-NB
42"	SB2942-20V-NB
48"	SB2948-20V-NB

Width	Item Number
30"	SB3230-20V-18-NB
36"	SB3236-20V-18-NB
42"	SB3242-20V-18-NB
48"	SB3248-20V-18-NB

Width	Item Number
30"	SB3230-20V-NB
36"	SB3236-20V-NB
42"	SB3242-20V-NB
48"	SB3248-20V-NB

Width	Item Number
30"	SB3530-20V-18-NB
36"	SB3536-20V-18-NB
42"	SB3542-20V-18-NB
48"	SB3548-20V-18-NB

Width	Item Number
30"	SB3530-20V-NB
36"	SB3536-20V-NB
42"	SB3542-20V-NB
48"	SB3548-20V-NB

Width	Item Number
24"	MOBILE-CART-24
36"	MOBILE-CART-36

(Standard depth of 22")

Width	Item Number
24"	MOBILE-CART-24-18
36"	MOBILE-CART-36-18

(Suffix 18 represents 18" depth)

Mobile Cabinets

All AMS cabinets are available in a mobile version including low profile (27.18" high), sitting height (28.75" high), ADA height (31.75" high), and standing height (34.75" high). They come standard with a finished back and optional finished top. To specify a mobile cabinet use the prefix "M" to the base cabinet model number (example: SMB2724-110). They come standard with a 3" caster. 2" casters are available by adding the suffix "-2" to the part number. Cabinet depth with finished back is 22.812". All mobile cabinets with drawers come standard with a tip resistant counter weight.

Tops: please add the suffix "T" for steel, "E" for epoxy, "P" for phenolic. All tops are 3/4" thick and with a 7/8" overhang on front only.

(example SMB2724-110L-T)

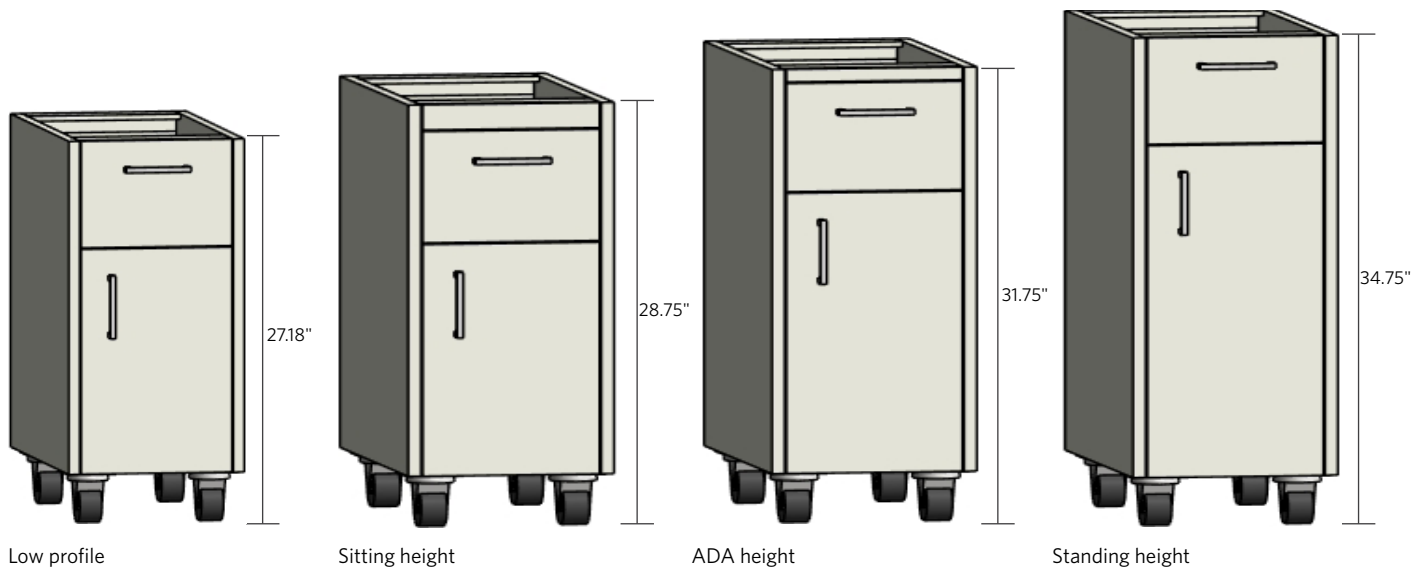

Hanging Cabinets

All AMS cabinets are available in a hanging version including low profile (23.18" high), sitting height (24.875" high), ADA height (27.875" high), and standing height (30.875" high). To specify a hanging cabinet use the prefix "H" to the base cabinet model number (example: SHB2324-110). Finished backs are optional and can be specified with the suffix "-FB". Low profile cabinets should be used for adjustable height work benches or table frames on casters to allow the caster to swivel if the adjustable leg is positioned in the lowest setting.

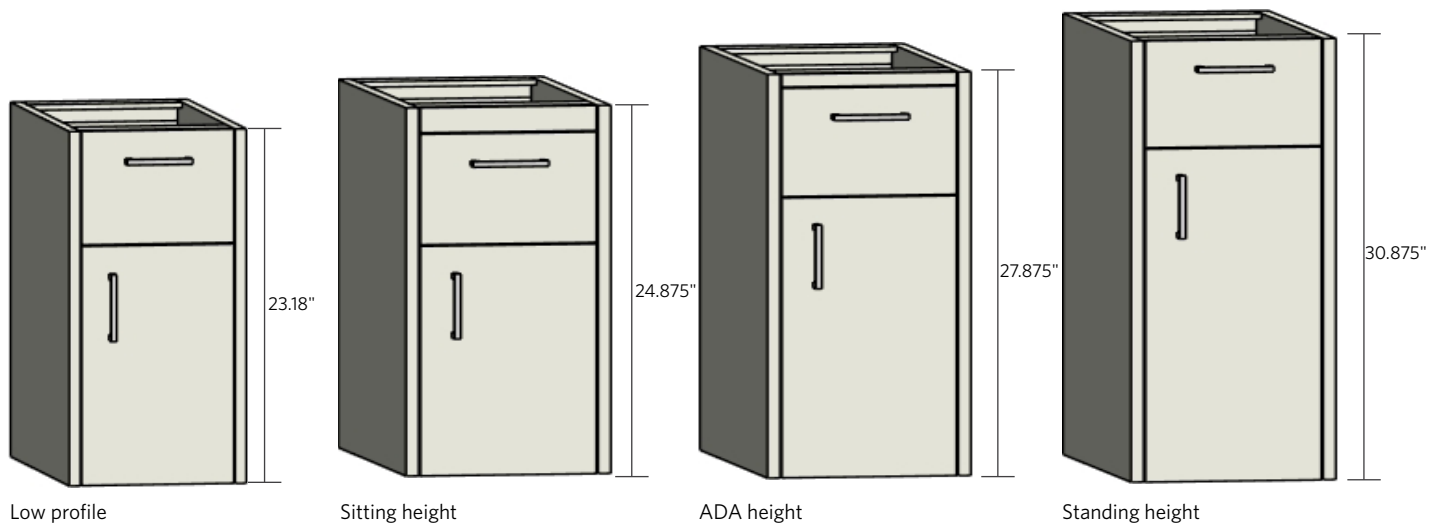

Tall Cabinets

Tall cabinets are 84" high and available in 16", 18", 21" and 24" deep by using the two digit suffix. Suffix is not needed when selecting 16" deep. Units are available in various widths as shown. Door units feature five shelves as standard. Additional shelves are available. Specify left- or right-hinged doors using the suffix "L" or "R" after the two digit depth number. If locks are required use the suffix "LK".

Wardrobe cabinets are available by adding the suffix "W" to any of the standard part numbers. They will include one hanging bar in lieu of shelves.

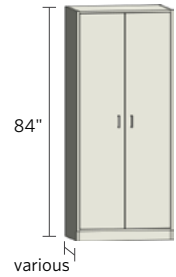

OPEN CABINETS



Up to 24" wide

Width	Item Number
18"	SF8418-000
24"	SF8424-000



30" and wider

Width	Item Number
30"	SF8430-000
36"	SF8436-000
42"	SF8442-000
48"	SF8448-000

DOOR CABINETS



Right-hinged door shown

Width	Left & Right Hinged
18"	SF8418-1SHL
24"	SF8424-1SHL
18"	SF8418-1SHR
24"	SF8424-1SHR



Width	Item Number
30"	SF8430-2SH
36"	SF8436-2SH
42"	SF8442-2SH
48"	SF8448-2SH



Width	Item Number
30"	SF8430-2SS
36"	SF8436-2SS
42"	SF8442-2SS
48"	SF8448-2SS

(this unit has sliding doors)



Width	Item Number
30"	SF8430-4SH
36"	SF8436-4SH
42"	SF8442-4SH
48"	SF8448-4SH

Tall Cabinets

Tall cabinets are 84" high and available in 16", 18", 21" and 24" deep by using the two digit suffix. Suffix is not needed when selecting 16" deep. Units are available in various widths as shown. Door units feature five shelves as standard. Additional shelves are available. Specify left- or right-hinged doors using the suffix "L" or "R" after the two digit depth number. If locks are required use the suffix "LK".

Wardrobe cabinets are available by adding the suffix "W" to any of the standard part numbers. They will include one hanging bar in lieu of shelves. For pull out shelves add the suffix "PS".

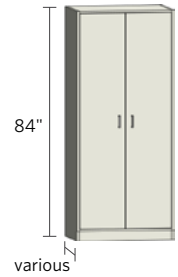

DOOR CABINETS



Right-hinged door shown

Width	Left & Right Hinged
18"	SF8418-1GHL
24"	SF8424-1GHL
18"	SF8418-1GHR
24"	SF8424-1GHR



Width	Item Number
30"	SF8430-2GH
36"	SF8436-2GH
42"	SF8442-2GH
48"	SF8448-2GH



Width	Item Number
30"	SF8430-2GSF
36"	SF8436-2GSF
42"	SF8442-2GSF
48"	SF8448-2GSF

(this unit has sliding doors)

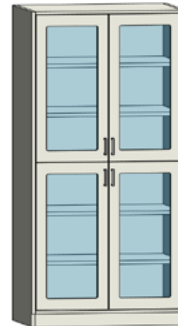

Width	Item Number
30"	SF8430-4GH
36"	SF8436-4GH
42"	SF8442-4GH
48"	SF8448-4GH



Width	Item Number
30"	SF8430-2GH2SH
36"	SF8436-2GH2SH
42"	SF8442-2GH2SH
48"	SF8448-2GH2SH

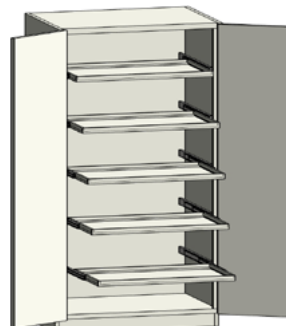

Pull out shelves are available upon request.

Wall Cabinets — 24" Height

Wall cabinets are available in 24", 30", 36" and 48" heights and come standard with a 13" depth. For 16" deep cabinets, use the suffix "16". Units are available in various widths as shown. They feature one shelf as standard for 24" units. Specify left- or right-hinged doors using the suffix "L" or "R" after the two digit depth number. If locks are required, use the suffix "LK".

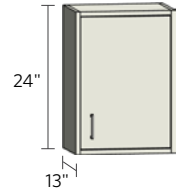

Example: **SW2430-2SS-16**

height: 24" (from SW2430-2SS-16)
 door Style: 2SS (from SW2430-2SS-16)
 width: 30" (from SW2430-2SS-16)
 number doors: 2 (from SW2430-2SS-16)
 depth: 16" (from SW2430-2SS-16)
note only needed for 16" deep. Leave blank for 13"

OPEN CABINETS

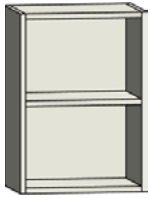

Up to 24" wide

Width	Item Number
18"	SW2418-000
24"	SW2424-000



30" and wider

Width	Item Number
30"	SW2430-000
36"	SW2436-000
42"	SW2442-000
48"	SW2448-000

STEEL-HINGED DOOR CABINETS

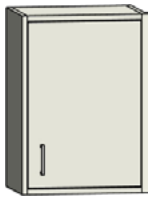

Right-hinged door shown

Width	Left & Right Hinged
18"	SW2418-1SHL
24"	SW2424-1SHL
18"	SW2418-1SHR
24"	SW2424-1SHR

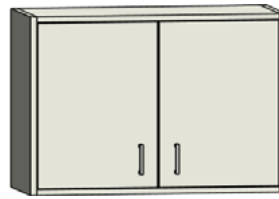

30" and wider

Width	Item Number
30"	SW2430-2SH
36"	SW2436-2SH
42"	SW2442-2SH
48"	SW2448-2SH

STEEL SLIDING DOOR CABINETS

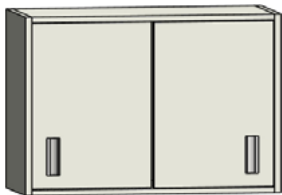

30" and wider

Width	Item Number
30"	SW2430-2SS
36"	SW2436-2SS
42"	SW2442-2SS
48"	SW2448-2SS

CORNER CABINETS

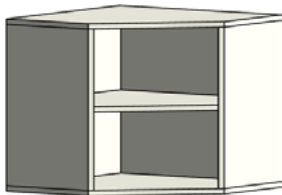

Item Number
SWC2418-000

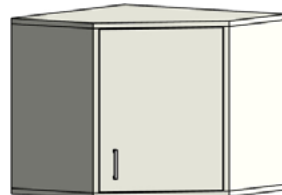

Right-hinged door shown

Left hinged	Right hinged
SWC2418-1SHL	SWC2418-1SHR

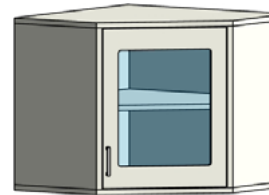

Left hinged	Right hinged
SWC2418-1GHL	SWC2418-1GHR

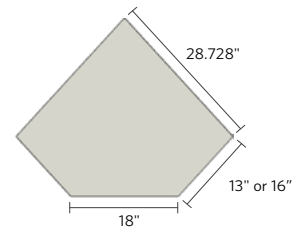

Wall Cabinets — 24" Height

Wall cabinets are available in 24", 30", 36" and 48" heights and come standard with a 13" depth. For 16" deep cabinets, use the suffix "16". Units are available in various widths as shown. They feature one shelf as standard for 24" units. Specify left- or right-hinged doors using the suffix "L" or "R" after the two digit depth number. If locks are required, use the suffix "LK".

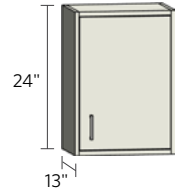

FRAMED GLASS HINGED DOOR CABINETS

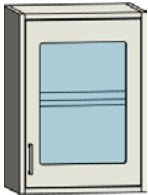

Right-hinged door shown

Width	Left & Right Hinged
18"	SW2418-1GHL
24"	SW2424-1GHL
18"	SW2418-1GHR
24"	SW2424-1GHR

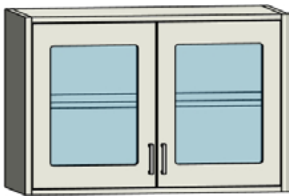

30" and wider

Width	Item Number
30"	SW2430-2GH
36"	SW2436-2GH
42"	SW2442-2GH
48"	SW2448-2GH

FRAMED GLASS SLIDING DOOR CABINETS

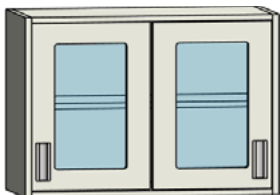

30" and wider

Width	Item Number
30"	SW2430-2GSF
36"	SW2436-2GSF
42"	SW2442-2GSF
48"	SW2448-2GSF

GLASS SLIDING DOOR CABINETS

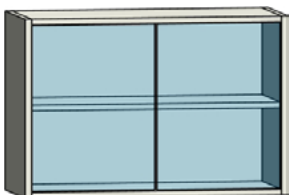

30" and wider

Width	Item Number
30"	SW2430-2GS
36"	SW2436-2GS
42"	SW2442-2GS
48"	SW2448-2GS

Wall Cabinets — 30" Height

Wall cabinets are available in 24", 30", 36" and 48" heights and come standard with a 13" depth. For 16" deep cabinets, use the suffix "16". Units are available in various widths as shown. They feature two shelves as standard for 30" units. Specify left- or right-hinged doors using the suffix "L" or "R" after the two digit depth number. If locks are required, use the suffix "LK".

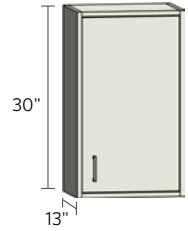

OPEN CABINETS

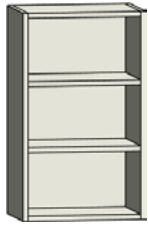

Up to 24" wide

Width	Item Number
18"	SW3018-000
24"	SW3024-000

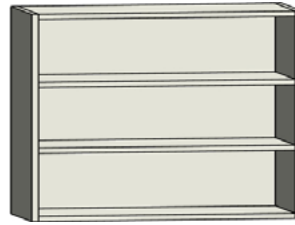

30" and wider

Width	Item Number
30"	SW3030-000
36"	SW3036-000
42"	SW3042-000
48"	SW3048-000

STEEL-HINGED DOOR CABINETS

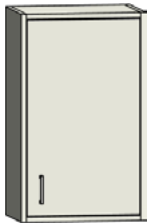

Right-hinged door shown

Width	Left & Right Hinged
18"	SW3018-1SHL
24"	SW3024-1SHL
18"	SW3018-1SHR
24"	SW3024-1SHR

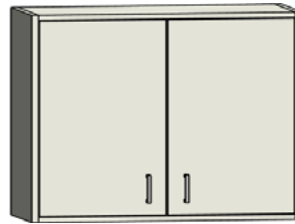

30" and wider

Width	Item Number
30"	SW3030-2SH
36"	SW3036-2SH
42"	SW3042-2SH
48"	SW3048-2SH

STEEL SLIDING DOOR CABINETS

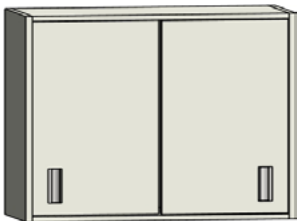

30" and wider

Width	Item Number
30"	SW3030-2SS
36"	SW3036-2SS
42"	SW3042-2SS
48"	SW3048-2SS

CORNER CABINETS

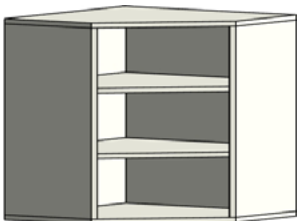

Item Number
SWC3018-000

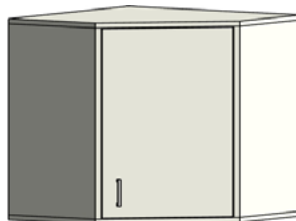

Left hinged	Right hinged
SWC3018-1SHL	SWC3018-1SHR

Right-hinged door shown

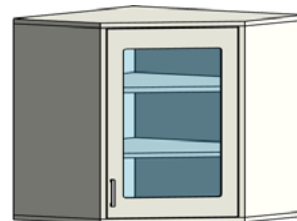

Left hinged	Right hinged
SWC3018-1GHL	SWC3018-1GHR

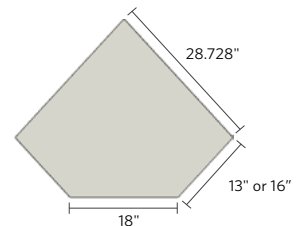

Wall Cabinets — 30" Height

Wall cabinets are available in 24", 30", 36" and 48" heights and come standard with a 13" depth. For 16" deep cabinets, use the suffix "16". Units are available in various widths as shown. They feature two shelves as standard for 30" units. Specify left- or right-hinged doors using the suffix "L" or "R" after the two digit depth number. If locks are required, use the suffix "LK".

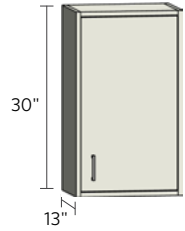

FRAMED GLASS HINGED DOOR CABINETS



Right-hinged door shown

Width	Left & Right Hinged
18"	SW3018-1GHL
24"	SW3024-1GHL
18"	SW3018-1GHR
24"	SW3024-1GHR



30" and wider

Width	Item Number
30"	SW3030-2GH
36"	SW3036-2GH
42"	SW3042-2GH
48"	SW3048-2GH

FRAMED GLASS SLIDING DOOR CABINETS

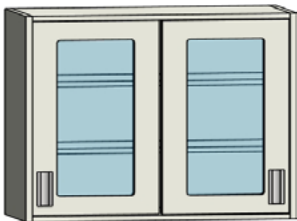

30" and wider

Width	Item Number
30"	SW3030-2GSF
36"	SW3036-2GSF
42"	SW3042-2GSF
48"	SW3048-2GSF

GLASS SLIDING DOOR CABINETS

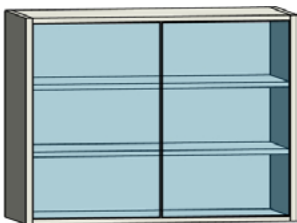

30" and wider

Width	Item Number
30"	SW3030-2GS
36"	SW3036-2GS
42"	SW3042-2GS
48"	SW3048-2GS

Wall Cabinets — 36" Height

Wall cabinets are available in 24", 30", 36" and 48" heights and come standard with a 13" depth. For 16" deep cabinets, use the suffix "16". Units are available in various widths as shown. They feature two shelves as standard for 36" units. Specify left- or right-hinged doors using the suffix "L" or "R" after the two digit depth number. If locks are required, use the suffix "LK".

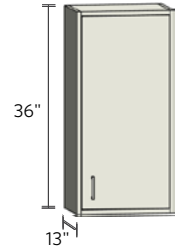

OPEN CABINETS

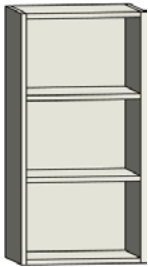

Up to 24" wide

Width	Item Number
18"	SW3618-000
24"	SW3624-000

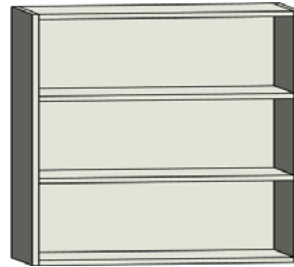

30" and wider

Width	Item Number
30"	SW3630-000
36"	SW3636-000
42"	SW3642-000
48"	SW3648-000

STEEL-HINGED DOOR CABINETS

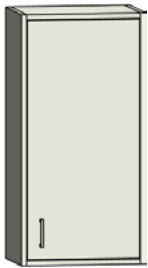

Right-hinged door shown

Width	Left & Right Hinged
18"	SW3618-1SHL
24"	SW3624-1SHL
18"	SW3618-1SHR
24"	SW3624-1SHR

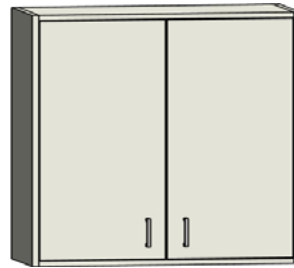

30" and wider

Width	Item Number
30"	SW3630-2SH
36"	SW3636-2SH
42"	SW3642-2SH
48"	SW3648-2SH

STEEL SLIDING DOOR CABINETS

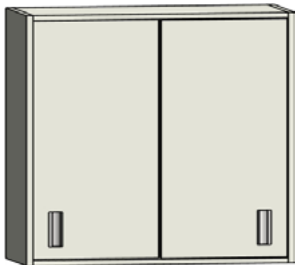

30" and wider

Width	Item Number
30"	SW3630-2SS
36"	SW3636-2SS
42"	SW3642-2SS
48"	SW3648-2SS

CORNER CABINETS

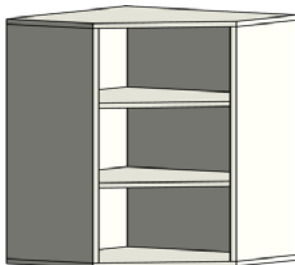

Item Number
SWC3618-000

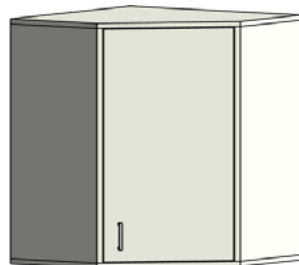

Left hinged	Right hinged
SWC3618-1SHL	SWC3618-1SHR

Right-hinged door shown

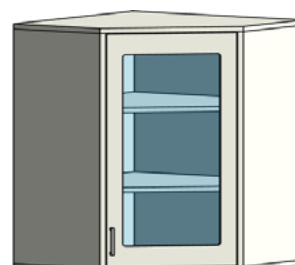

Left hinged	Right hinged
SWC3618-1GHL	SWC3618-1GHR

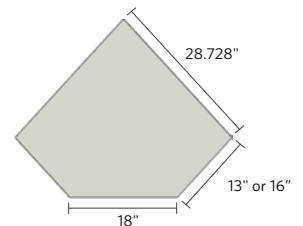

Wall Cabinets — 36" Height

Wall cabinets are available in 24", 30", 36" and 48" heights and come standard with a 13" depth. For 16" deep cabinets, use the suffix "16". Units are available in various widths as shown. They feature two shelves as standard for 36" units. Specify left- or right-hinged doors using the suffix "L" or "R" after the two digit depth number. If locks are required, use the suffix "LK".

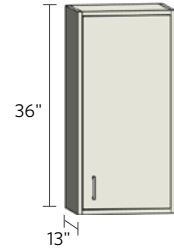

FRAMED GLASS HINGED DOOR CABINETS

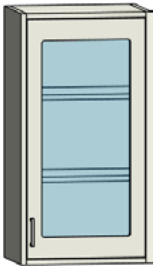

Right-hinged door shown

Width	Left & Right Hinged
18"	SW3618-1GHL
24"	SW3624-1GHL
18"	SW3618-1GHR
24"	SW3624-1GHR

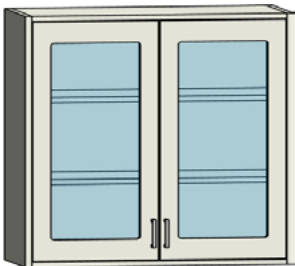

30" and wider

Width	Item Number
30"	SW3630-2GH
36"	SW3636-2GH
42"	SW3642-2GH
48"	SW3648-2GH

FRAMED GLASS SLIDING DOOR CABINETS

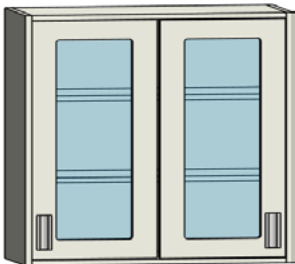

30" and wider

Width	Item Number
30"	SW3630-2GSF
36"	SW3636-2GSF
42"	SW3642-2GSF
48"	SW3648-2GSF

GLASS SLIDING DOOR CABINETS

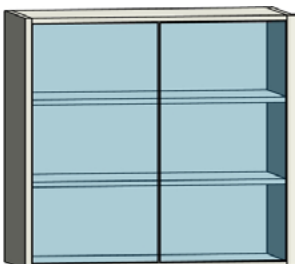

30" and wider

Width	Item Number
30"	SW3630-2GS
36"	SW3636-2GS
42"	SW3642-2GS
48"	SW3648-2GS

Wall Cabinets — 48" Height

Wall cabinets are available in 24", 30", 36" and 48" heights and come standard with a 13" depth. For 16" deep cabinets, use the suffix "16". Units are available in various widths as shown. They feature three shelves as standard for 48" units. Specify left- or right-hinged doors using the suffix "L" or "R" after the two digit depth number. If locks are required, use the suffix "LK".

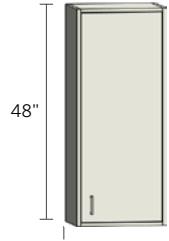

OPEN CABINETS

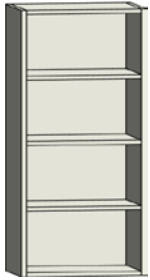

Up to 24" wide

Width	Item Number
18"	SW4818-000
24"	SW4824-000

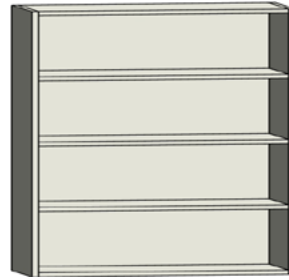

30" and wider

Width	Item Number
30"	SW4830-000
36"	SW4836-000
42"	SW4842-000
48"	SW4848-000

STEEL-HINGED DOOR CABINETS

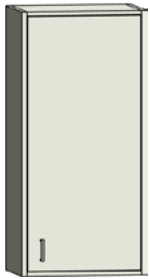

Right-hinged door shown

Width	Left & Right Hinged
18"	SW4818-1SHL
24"	SW4824-1SHL
18"	SW4818-1SHR
24"	SW4824-1SHR

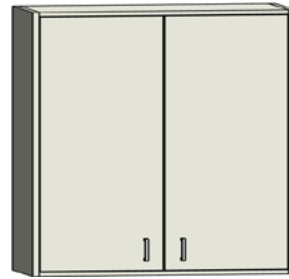

30" and wider

Width	Item Number
30"	SW4830-2SH
36"	SW4836-2SH
42"	SW4842-2SH
48"	SW4848-2SH

STEEL SLIDING DOOR CABINETS

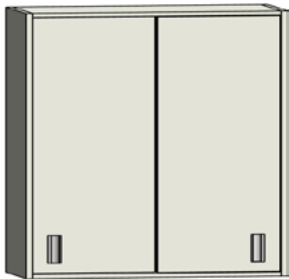

30" and wider

Width	Item Number
30"	SW4830-2SS
36"	SW4836-2SS
42"	SW4842-2SS
48"	SW4848-2SS

CORNER CABINETS

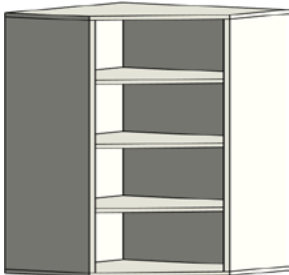

Item Number
SWC4818-000

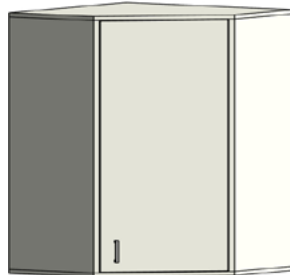

Left hinged	Right hinged
SWC4818-1SHL	SWC4818-1SHR

Right-hinged door shown

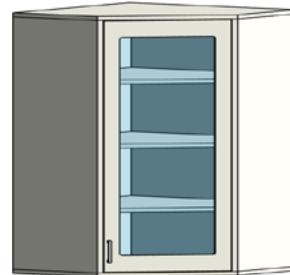

Left hinged	Right hinged
SWC4818-1GHL	SWC4818-1GHR

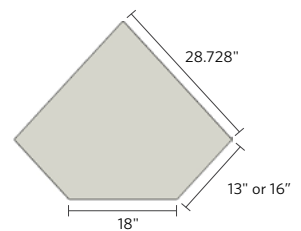

Wall Cabinets — 48" Height

Wall cabinets are available in 24", 30", 36" and 48" heights and come standard with a 13" depth. For 16" deep cabinets, use the suffix "16". Units are available in various widths as shown. They feature three shelves as standard for 48" units. Specify left- or right-hinged doors using the suffix "L" or "R" after the two digit depth number. If locks are required, use the suffix "LK".

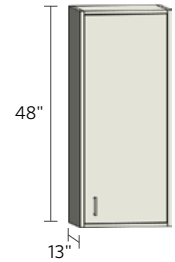

FRAMED GLASS HINGED DOOR CABINETS

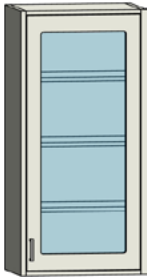

Right-hinged door shown

Width	Left & Right Hinged
18"	SW4818-1GHL
24"	SW4824-1GHL
18"	SW4818-1GHR
24"	SW4824-1GHR

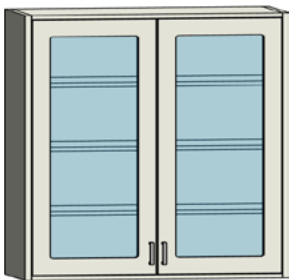

30" and wider

Width	Item Number
30"	SW4830-2GH
36"	SW4836-2GH
42"	SW4842-2GH
48"	SW4848-2GH

FRAMED GLASS SLIDING DOOR CABINETS

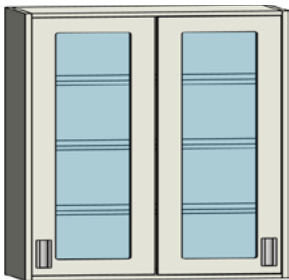

30" and wider

Width	Item Number
30"	SW4830-2GSF
36"	SW4836-2GSF
42"	SW4842-2GSF
48"	SW4848-2GSF

GLASS SLIDING DOOR CABINETS

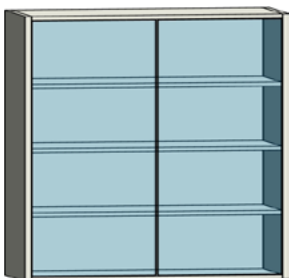

30" and wider

Width	Item Number
30"	SW4830-2GS
36"	SW4836-2GS
42"	SW4842-2GS
48"	SW4848-2GS

Aprons

Aprons have the options to be ordered in depths of 22" and 28". The aprons can have up to three drawers if the width allows. If end covers are required, use the suffix "EC".

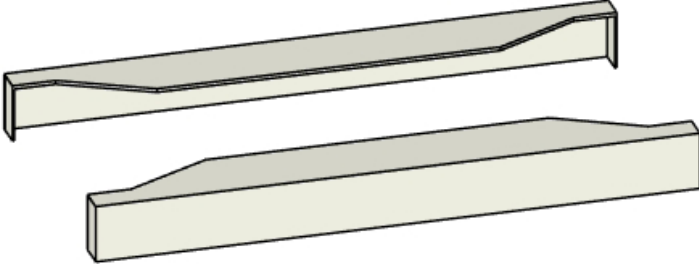

Width	Item Number	Item Number
24"	SA042422-000	SA042428-000
30"	SA043022-000	SA043028-000
36"	SA043622-000	SA043628-000
42"	SA044222-000	SA044228-000
48"	SA044822-000	SA044828-000
54"	SA045422-000	SA045428-000
60"	SA046022-000	SA046028-000
66"	SA046622-000	SA046628-000
72"	SA047222-000	SA047228-000

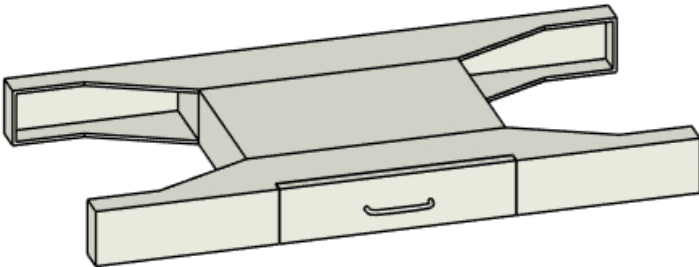

Width	Item Number	Item Number
24"	SA042422-001	SA042428-001
30"	SA043022-001	SA043028-001
36"	SA043622-001	SA043628-001
42"	SA044222-001	SA044228-001

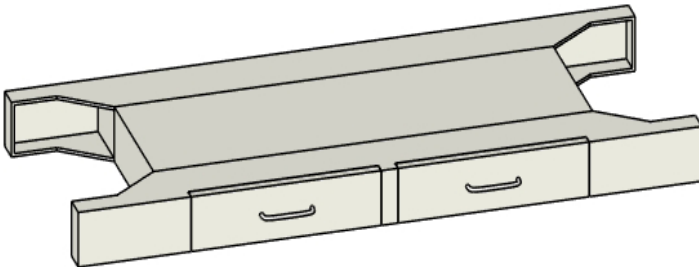

Width	Item Number	Item Number
42"	SA044222-002	SA044228-002
48"	SA044822-002	SA044828-002
54"	SA045422-002	SA045428-002
60"	SA046022-002	SA046028-002
66"	SA046622-002	SA046628-002
72"	SA047222-002	SA047228-002

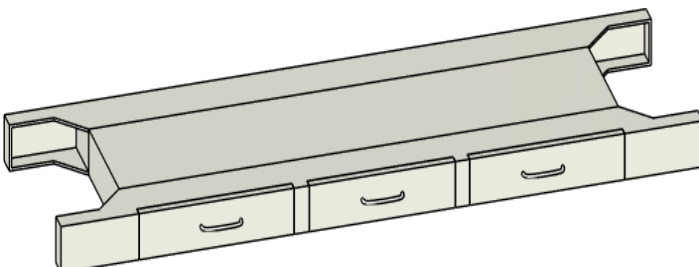

Width	Item Number	Item Number
72"	SA047222-003	SA047228-003

Utility Tables

Utility Tables can be ordered in 29", 32", and 35" height. The frame width is 2" less than nominal size. The frame Depth can be 22"(22.625) deep and 28" deep. Utility Tables are shipped unassembled.

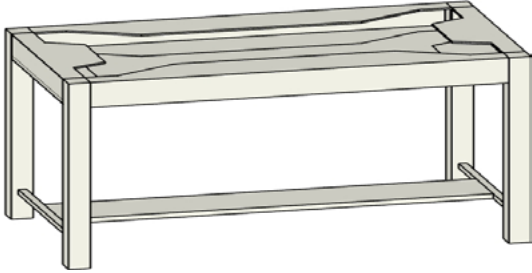

Width	Item Number	Item Number
24"	SUT292422-000	SUT292428-000
30"	SUT293022-000	SUT293028-000
36"	SUT293622-000	SUT293628-000
42"	SUT294222-000	SUT294228-000
48"	SUT294822-000	SUT294828-000
54"	SUT295422-000	SUT295428-000
60"	SUT296022-000	SUT296028-000
66"	SUT296622-000	SUT296628-000
72"	SUT297222-000	SUT297228-000

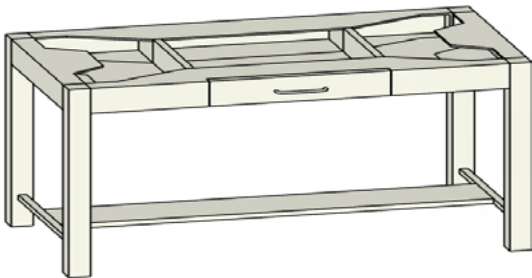

Width	Item Number	Item Number
30"	SUT293022-001	SUT293028-001
36"	SUT293622-001	SUT293628-001
42"	SUT294222-001	SUT294228-001

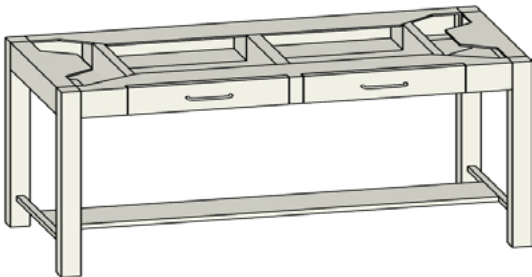

Width	Item Number	Item Number
42"	SUT294222-002	SUT294228-002
48"	SUT294822-002	SUT294828-002
54"	SUT295422-002	SUT295428-002
60"	SUT296022-002	SUT296028-002
66"	SUT296622-002	SUT296628-002
72"	SUT297222-002	SUT297228-002

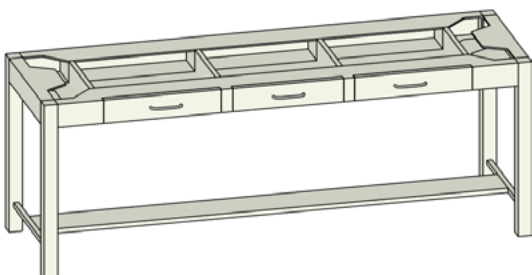

Width	Item Number	Item Number
72"	SUT297222-003	SUT297228-003

Filler Panels

Base cabinet filler panels are available in 29", 32" and 35" high. Floor case filler panels are available in 84" high. They are all available in any width required by entering the dimension in lieu of the "XX" in the part number. Note: AMS base cabinets are 22.375" deep. (Example: SLF35-6.625)

C-FILLER

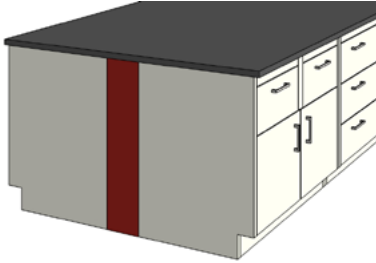

Item Number	Item Number	Item Number
SCF29-XX	SCF32-XX	SCF35-XX

C-FRONT FILLER



Item Number	Item Number	Item Number
SFFC29-XX	SFFC32-XX	SFFC35-XX

L-FILLER

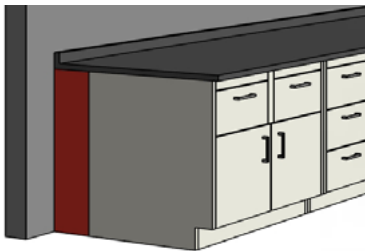

Item Number	Item Number	Item Number
SLF29-XX	SLF32-XX	SLF35-XX

L-FRONT FILLER

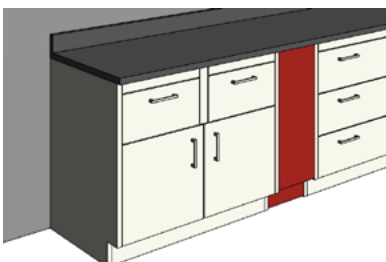

Item Number	Item Number	Item Number
SFFL29-XX	SFFL32-XX	SFFL35-XX

Filler Panels

Base cabinet filler panels are available in 29", 32" and 35" high. Floor case filler panels are available in 84" high. They are all available in any width required by entering the dimension in lieu of the "XX" in the part number. Note: AMS base cabinets are 22.375" deep. (Example: SLF35-6.625)

CORNER FILLER



Item Number	Item Number	Item Number
SICF29-XX	SICF32-XX	SICF35-XX

FLOOR CASE FILLER



Item Number
SFFL84-XX

TOE SPACE FILLER



Item Number
STSF-XX

WALL CASE FRONT FILLER

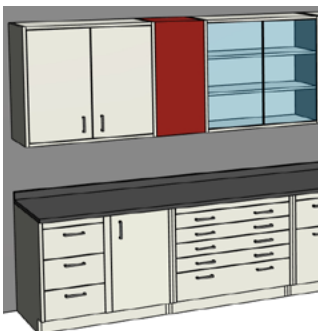

Item Number	Item Number	Item Number	Item Number
SWCFF24-XX	SWCFF30-XX	SWCFF36-XX	SWCFF48-XX

Wall cabinet front filler panels are available in 24", 30", 36" and 48" high. They are all available in any width required by entering the dimension in lieu of the "XX" in the part number. To specify the depth use the suffix "-13" or "-16".

WALL CASE CORNER FILLER

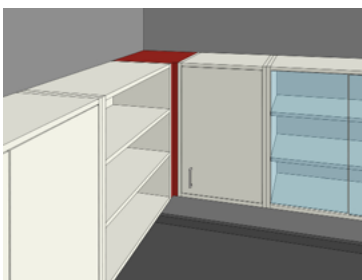

Item Number	Item Number	Item Number	Item Number
SWCCF24	SWCCF30	SWCCF36	SWCCF48

Knee Space Rails And Panels

KNEE SPACE RAILS

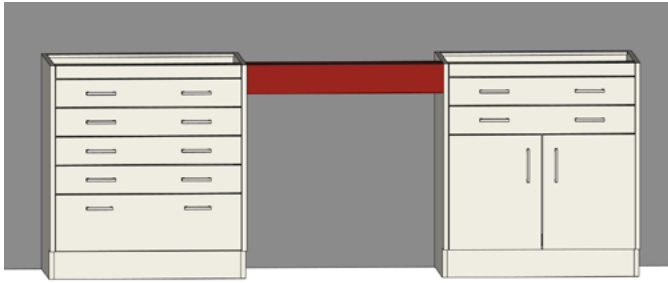

Item Number
SKSR0418
SKSR0424
SKSR0430
SKSR0436
SKSR0442
SKSR0448
SKSR0452
SKSR0454
SKSR0460
SKSR0466
SKSR0472
SKSR0484
SKSR0496

KNEE SPACE PANELS



Item Number	Item Number	Item Number
SKSP2424	SKSP2924	SKSP3524
SKSP2430	SKSP2930	SKSP3530
SKSP2436	SKSP2936	SKSP3536
SKSP2442	SKSP2942	SKSP3542
SKSP2448	SKSP2948	SKSP3548
SKSP2454	SKSP2954	SKSP3554
SKSP2460	SKSP2960	SKSP3560
SKSP2466	SKSP2966	SKSP3566
SKSP2472	SKSP2972	SKSP3572



The suffix "-2P" represents two piece panels.

Item Number	Item Number	Item Number
SKSP2424-2P	SKSP2924-2P	SKSP3524-2P
SKSP2430-2P	SKSP2930-2P	SKSP3530-2P
SKSP2436-2P	SKSP2936-2P	SKSP3536-2P
SKSP2442-2P	SKSP2942-2P	SKSP3542-2P
SKSP2448-2P	SKSP2948-2P	SKSP3548-2P
SKSP2454-2P	SKSP2954-2P	SKSP3554-2P
SKSP2460-2P	SKSP2960-2P	SKSP3560-2P
SKSP2466-2P	SKSP2966-2P	SKSP3566-2P
SKSP2472-2P	SKSP2972-2P	SKSP3572-2P



The suffix "-3P" represents three piece panels.

Item Number	Item Number	Item Number
SKSP2424-3P	SKSP2924-3P	SKSP3524-3P
SKSP2430-3P	SKSP2930-3P	SKSP3530-3P
SKSP2436-3P	SKSP2936-3P	SKSP3536-3P
SKSP2442-3P	SKSP2942-3P	SKSP3542-3P
SKSP2448-3P	SKSP2948-3P	SKSP3548-3P
SKSP2454-3P	SKSP2954-3P	SKSP3554-3P
SKSP2460-3P	SKSP2960-3P	SKSP3560-3P
SKSP2466-3P	SKSP2966-3P	SKSP3566-3P
SKSP2472-3P	SKSP2972-3P	SKSP3572-3P

CABINET FINISHED BACKS

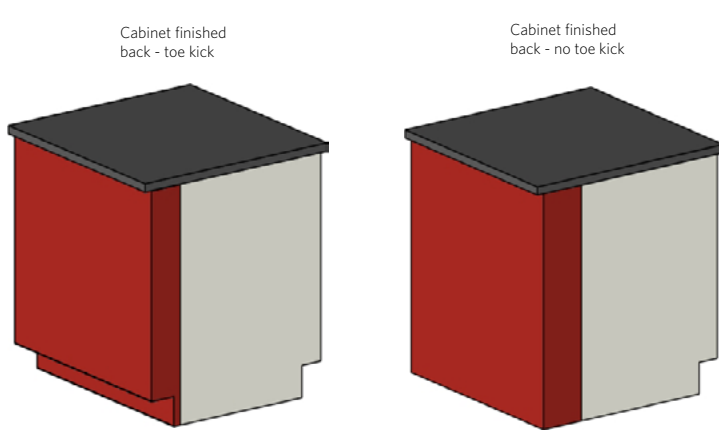

Cabinet finished backs come standard with a toe kick. Finished backs can be applied to a multitude of cabinets. The example above represents the layout for the part number. The height, width, and depth must match the cabinet that the finished back is to be applied too. If you do not want a toe kick on your unit be sure to put the suffix "NTK" at the end of the part number.

accessories

END PEDESTALS

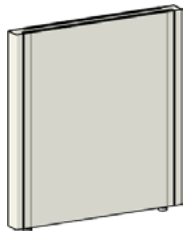

Item Number
SEP2902-22
SEP2902-28
SEP3502-22
SEP3502-28

TABLE LEGS

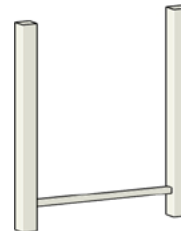

Item Number
SL29-22
SL29-28
SL35-22
SL35-28

SINGLE LEG

SINGLE LEG WITH PLATE

CORNER SLOPED TOP

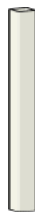

Item Number
SSL-29
SSL-35



Item Number
SSL-29P
SSL-35P

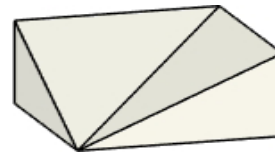

Item Number
SST-Corner13
SST-Corner16
SST-Corner21

SLOPED TOP WITH END CAPS



Item Number	Item Number	Item Number
SST13-18	SST16-18	SST21-18
SST13-24	SST16-24	SST21-24
SST13-30	SST16-30	SST21-30
SST13-36	SST16-36	SST21-36
SST13-42	SST16-42	SST21-42
SST13-48	SST16-48	SST21-48

SHELVES



Item Number	Item Number	Item Number	Item Number
SWS1813	SWS1816	SFS1816	SFS1821
SWS2413	SWS2416	SFS2416	SFS2421
SWS3013	SWS3016	SFS3016	SFS3021
SWS3613	SWS3616	SFS3616	SFS3621
SWS4213	SWS4216	SFS4216	SFS4221
SWS4813	SWS4816	SFS4816	SFS4821



Air Master Systems Corp.

6480 Norton Center Drive, Muskegon, MI 49441 • 231.798.1111 • 231.798.4000 fax • airmastersystems.com