



Titan Series Adaptable Systems

product catalog





Since 1975, Air Master Systems has manufactured chemical fume hoods, filtration hoods, and laboratory furniture for the research & development, institutional, industrial, government and biotech markets.



Contents

Titan Systems	4
Titan T12	5
Load Ratings	5
Box Core	6
Lower Box Core	7
Titan T9	8
Load Ratings	8
Box Core	9
Lower Box Core	10
Titan T6	11
Load Ratings	11
Box Core	12
Lower Box Core	13
Titan T3	14
Load Ratings	14
Island Panel Box Core	15
Island Panel Lower Box Core	16
Wall Panel Box Core	17
Wall Panel Lower Box Core	18
Island Shelf System	19
Titan Box Frame	20
Box Frame Assembly	20
Box Frame	21
Box Frame Shared	22
Titan Side Removable Panels	23
Titan Shelf Kits	24
Standard Depth Kits	24
Extended Depth Kits	25
Standard Bracket Kits	26
Inner Shelf Kits	26
Cantilever Table Frame	27
Wall Rails	28
Load Ratings	28
Wall Rails System	29
Standard Titan Wall Shelf Kits	30
Wall Standards	31
Heavy Duty Wall Rails	32
Load Ratings	32
Heavy Duty Wall Rails	33
Heavy Duty Shelf Kits	34
Titan Mobile Carts	35
Load Ratings	35
Mobile Carts	36
Titan Mobile Cart Components	37
Heavy Duty Mobile Carts	38
Load Ratings	38
Mobile Carts	39
Heavy Duty Mobile Cart Components	40
Titan Work Bench	41
Work Bench (No Services)	41
Work Bench (With Services)	42
Table Frame	43
Titan Systems Accessories	44
Titan Core Raceway	44
Titan Hanging Rail Kit	44
Under Shelf Task Lights	45
ECON Light	45
TUCK Light	46

Note:

Images in this catalog are for representation only. For complete product specifications, contact your AMS representative.

Titan Systems

The complete versatility of the Titan system will handle a multitude of functions in the laboratory environment. The system is extremely adaptable and durable to exceed your laboratory needs. The core has slotted uprights for shelving, table frames, and cabinet options.



Key Features

- Titan Core System configurations can be readily created and easily changed as well as moved for new applications or changing space.
- Can be used in conjunction with suspended, mobile or floor-mounted casework.
- Solid durable construction
- Includes a fine adjust leveling foot
- Static capacity of 2600lbs (on a double sided, four shelves, two table frame unit) SEFA tested
- Cantilever table frames available in depths of 24" & 30"
- Available in: 24", 30", 36" 42", 48", 54", 60", 72"
- Cabinets: mobile, hanging, or floor mounted ordered separately
- Counter top options available in Phenolic & Epoxy
- Order shelving separately. Shelf brackets are adjustable in 1" increments to allow for multiple configurations. Shelf depths vary based on necessity.
- Standard shelves are 12", 14", 16" , and 18" deep. Shelves can be flush to the core uprights or inset 6" between core uprights. 12" inner shelves available to work in conjunction with standard exterior shelves.



Titan T12 - Box Core

The Titan T12 box core is 84 5/16" tall and available from 24" to 72" wide, with levelers having 1" of adjustment. The unit is floor mounted for wall or island configurations. The box core has components such as: shelving, cantilever frame, structural cantilever table, and suspended cabinets. All components attaching to the core are ordered separately. Electrical, data or plumbing services are available in lower fixed and reagent panels.

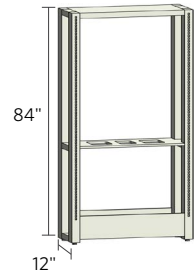

T12 BOX CORE LOAD RATINGS

Parts	Loading Rate
Top Shelf	100lbs
Shelving	200lbs
Hanging Cabinet	300lbs
Upper Hanging Cabinet	300lbs
Cantilevered Table Work Frame	800lbs
Total Core Assembly	2,500lbs

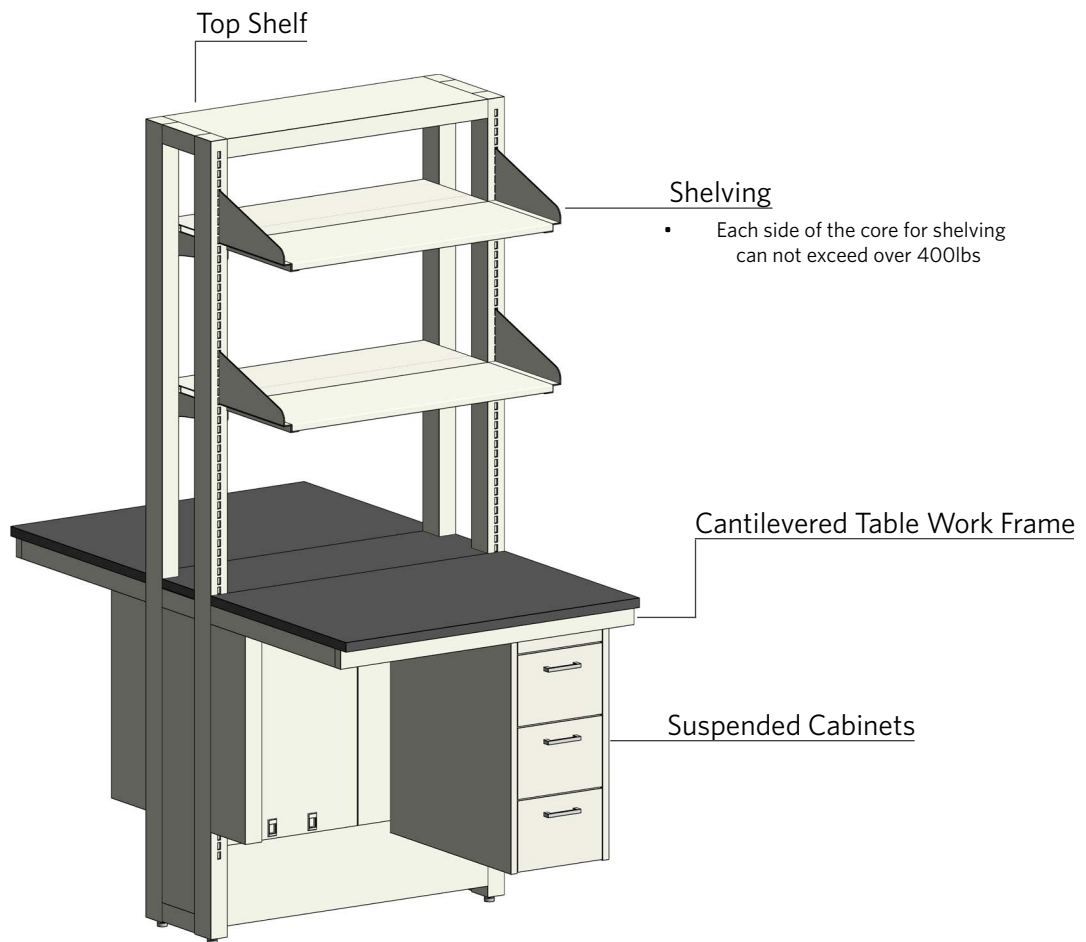

Titan T12 - Box Core

The Titan T12 box core is 84 5/16" High, available from 24" to 72" wide, and has levelers with 1" adjustment. The unit is floor mounted making it suitable for wall or island configurations, where general services are needed. The box core has components such as inserts, shelves, cantilever table, structural cantilever table, and hanging Cabinets. All the components are ordered separately. Another feature is the option of having removable panels and to indicate removable panels change (0) to (2). For epoxy or phenolic tops, replace N for E or P respectively. Electrical services are available in lower fixed and reagent panels. For more information please contact sales representatives.

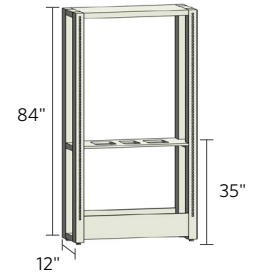

12" DEPTH BOX CORE - FULL HEIGHT

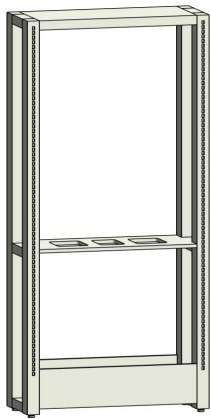

No Lower Removable Panels

Width	Item Number
24"	T12-BC-2484-0N
30"	T12-BC-3084-0N
36"	T12-BC-3684-0N
42"	T12-BC-4284-0N
48"	T12-BC-4884-0N
54"	T12-BC-5484-0N
60"	T12-BC-6084-0N
66"	T12-BC-6684-0N
72"	T12-BC-7284-0N

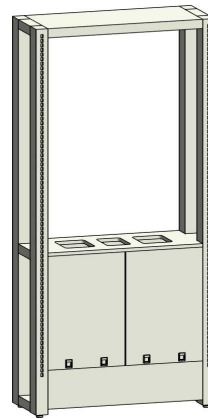

With Lower Removable Panels

Width	Item Number
24"	T12-BC-2484-2N
30"	T12-BC-3084-2N
36"	T12-BC-3684-2N
42"	T12-BC-4284-2N
48"	T12-BC-4884-2N
54"	T12-BC-5484-2N
60"	T12-BC-6084-2N
66"	T12-BC-6684-2N
72"	T12-BC-7284-2N

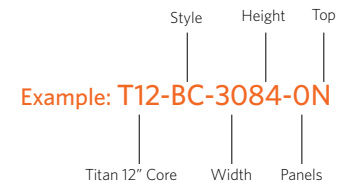

12" DEPTH REAGENT BOX CORE - FULL HEIGHT

The reagent box core is featuring a 12" tall reagent panel.

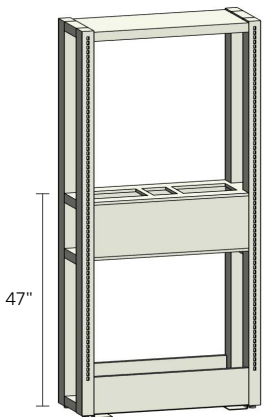

No Lower Removable Panels

Width	Item Number
24"	T12-RBC-2484-0N
30"	T12-RBC-3084-0N
36"	T12-RBC-3684-0N
42"	T12-RBC-4284-0N
48"	T12-RBC-4884-0N
54"	T12-RBC-5484-0N
60"	T12-RBC-6084-0N
66"	T12-RBC-6684-0N
72"	T12-RBC-7284-0N

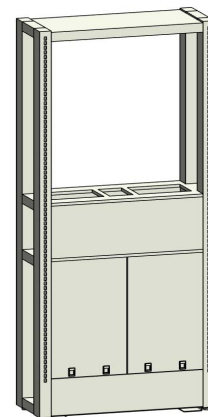

With Lower Removable Panels

Width	Item Number
24"	T12-RBC-2484-2N
30"	T12-RBC-3084-2N
36"	T12-RBC-3684-2N
42"	T12-RBC-4284-2N
48"	T12-RBC-4884-2N
54"	T12-RBC-5484-2N
60"	T12-RBC-6084-2N
66"	T12-RBC-6684-2N
72"	T12-RBC-7284-2N

Titan T12 — Lower Box Core

The Titan T12 lower box core is 35 or 47" tall and available from 24" to 72" wide, with levelers having 1" of adjustment. The unit is floor mounted for wall or island configurations. The lower box core has components such as: shelving, cantilever frame, structural cantilever table, and suspended cabinets. All components attaching to the core are ordered separately. Electrical, data or plumbing services are available in lower fixed and reagent panels.

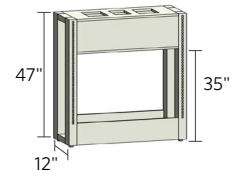

12" DEPTH BOX CORE - LOWER HEIGHT

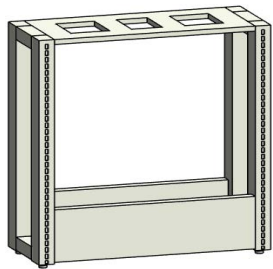

No Lower Removable Panels

Width	Item Number
24"	T12-LC-2435-0N
30"	T12-LC-3035-0N
36"	T12-LC-3635-0N
42"	T12-LC-4235-0N
48"	T12-LC-4835-0N
54"	T12-LC-5435-0N
60"	T12-LC-6035-0N
66"	T12-LC-6635-0N
72"	T12-LC-7235-0N

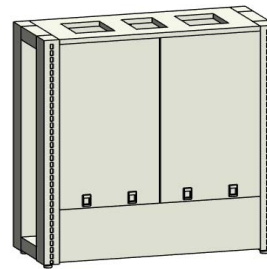

With Lower Removable Panels

Width	Item Number
24"	T12-LC-2435-2N
30"	T12-LC-3035-2N
36"	T12-LC-3635-2N
42"	T12-LC-4235-2N
48"	T12-LC-4835-2N
54"	T12-LC-5435-2N
60"	T12-LC-6035-2N
66"	T12-LC-6635-2N
72"	T12-LC-7235-2N

12" DEPTH REAGENT BOX CORE - LOWER HEIGHT

The reagent box core is featuring a 12" tall reagent panel.

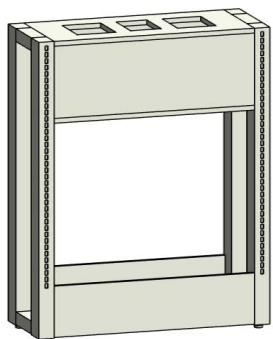

No Lower Removable Panels

Width	Item Number
24"	T12-RLC-2447-0N
30"	T12-RLC-3047-0N
36"	T12-RLC-3647-0N
42"	T12-RLC-4247-0N
48"	T12-RLC-4847-0N
54"	T12-RLC-5447-0N
60"	T12-RLC-6047-0N
66"	T12-RLC-6647-0N
72"	T12-RLC-7247-0N

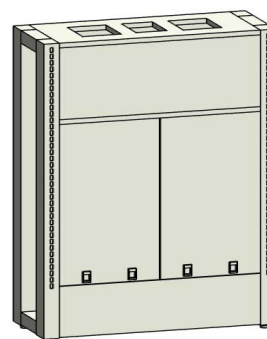

With Lower Removable Panels

Width	Item Number
24"	T12-RLC-2447-2N
30"	T12-RLC-3047-2N
36"	T12-RLC-3647-2N
42"	T12-RLC-4247-2N
48"	T12-RLC-4847-2N
54"	T12-RLC-5447-2N
60"	T12-RLC-6047-2N
66"	T12-RLC-6647-2N
72"	T12-RLC-7247-2N

Titan T9 - Box Core

The Titan T9 box core is 84 5/16" tall and available from 24" to 72" wide, with levelers having 1" of adjustment. The unit is floor mounted for wall configurations. The box core has components such as: shelving, cantilever frame, structural cantilever table, and suspended cabinets. All components attaching to the core are ordered separately. Electrical, data or plumbing services are available in lower fixed and reagent panels.

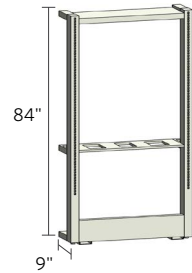

T9 BOX CORE LOAD RATINGS

Parts	Loading Rate
Top Shelf	100lbs
Shelving	200lbs
Cantileverd Table Work Frame	800lbs
Total Core Assembly	1,300lbs

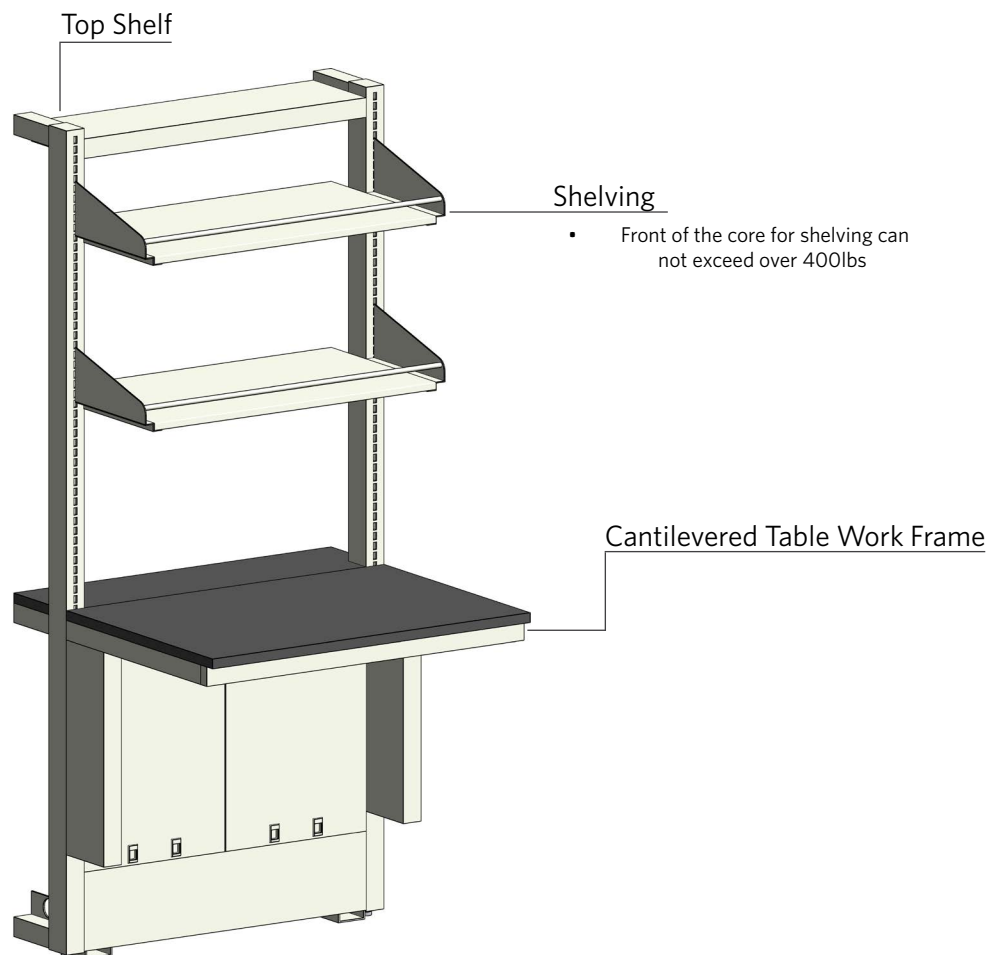

Titan T9 — Box Core

Style
Height
Top
Example: T9-BC-3084-0N
Titan 9" Core
Width
Panels

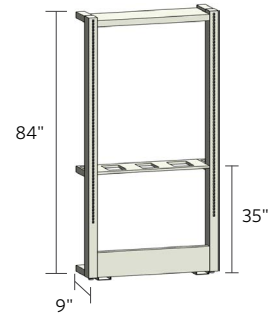

9" DEPTH BOX CORE - FULL HEIGHT

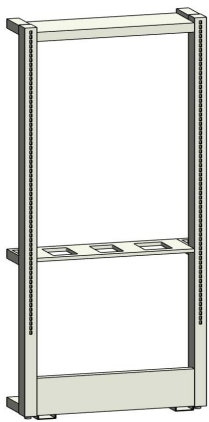

No Lower Removable Panels

Width	Item Number
24"	T9-BC-2484-0N
30"	T9-BC-3084-0N
36"	T9-BC-3684-0N
42"	T9-BC-4284-0N
48"	T9-BC-4884-0N
54"	T9-BC-5484-0N
60"	T9-BC-6084-0N
66"	T9-BC-6684-0N
72"	T9-BC-7284-0N

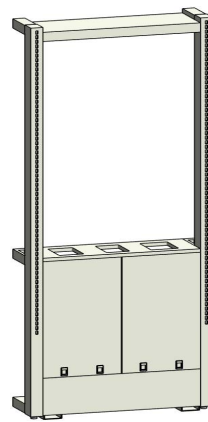

With Lower Removable Panels

Width	Item Number
24"	T9-BC-2484-2N
30"	T9-BC-3084-2N
36"	T9-BC-3684-2N
42"	T9-BC-4284-2N
48"	T9-BC-4884-2N
54"	T9-BC-5484-2N
60"	T9-BC-6084-2N
66"	T9-BC-6684-2N
72"	T9-BC-7284-2N

9" DEPTH REAGENT BOX CORE - FULL HEIGHT

The reagent box core is featuring a 12" tall reagent panel.

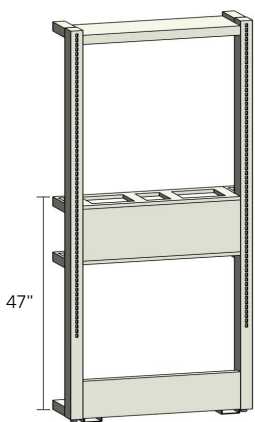

No Lower Removable Panels

Width	Item Number
24"	T9-RBC-2484-0N
30"	T9-RBC-3084-0N
36"	T9-RBC-3684-0N
42"	T9-RBC-4284-0N
48"	T9-RBC-4884-0N
54"	T9-RBC-5484-0N
60"	T9-RBC-6084-0N
66"	T9-RBC-6684-0N
72"	T9-RBC-7284-0N

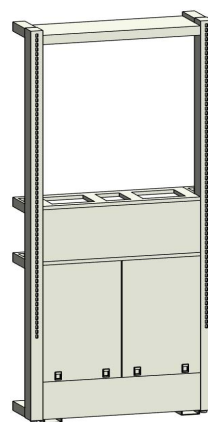

With Lower Removable Panels

Width	Item Number
24"	T9-RBC-2484-2N
30"	T9-RBC-3084-2N
36"	T9-RBC-3684-2N
42"	T9-RBC-4284-2N
48"	T9-RBC-4884-2N
54"	T9-RBC-5484-2N
60"	T9-RBC-6084-2N
66"	T9-RBC-6684-2N
72"	T9-RBC-7284-2N

Titan T9 — Lower Box Core

Designed for wall configurations where services and are required. Electrical, data or plumbing services including cup sinks can be accomodated.

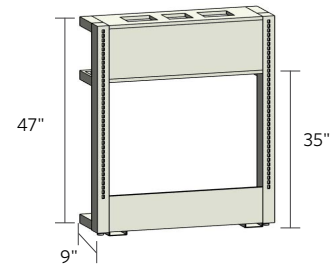

9" DEPTH BOX CORE - LOWER HEIGHT

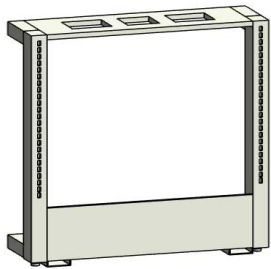

No Lower Removable Panels

Width	Item Number
24"	T9-LC-2435-0N
30"	T9-LC-3035-0N
36"	T9-LC-3635-0N
42"	T9-LC-4235-0N
48"	T9-LC-4835-0N
54"	T9-LC-5435-0N
60"	T9-LC-6035-0N
66"	T9-LC-6635-0N
72"	T9-LC-7235-0N

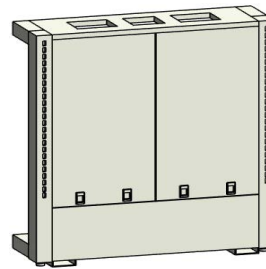

With Lower Removable Panels

Width	Item Number
24"	T9-LC-2435-2N
30"	T9-LC-3035-2N
36"	T9-LC-3635-2N
42"	T9-LC-4235-2N
48"	T9-LC-4835-2N
54"	T9-LC-5435-2N
60"	T9-LC-6035-2N
66"	T9-LC-6635-2N
72"	T9-LC-7235-2N

9" DEPTH REAGENT BOX CORE - LOWER HEIGHT

The reagent box core is featuring a 12" tall reagent panel.

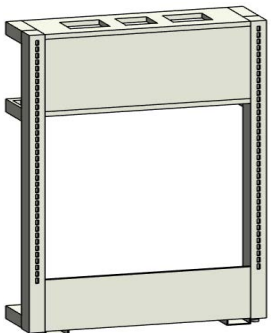

No Lower Removable Panels

Width	Item Number
24"	T9-RLC-2447-0N
30"	T9-RLC-3047-0N
36"	T9-RLC-3647-0N
42"	T9-RLC-4247-0N
48"	T9-RLC-4847-0N
54"	T9-RLC-5447-0N
60"	T9-RLC-6047-0N
66"	T9-RLC-6647-0N
72"	T9-RLC-7247-0N

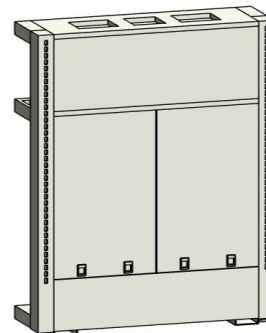

With Lower Removable Panels

Width	Item Number
24"	T9-RLC-2447-2N
30"	T9-RLC-3047-2N
36"	T9-RLC-3647-2N
42"	T9-RLC-4247-2N
48"	T9-RLC-4847-2N
54"	T9-RLC-5447-2N
60"	T9-RLC-6047-2N
66"	T9-RLC-6647-2N
72"	T9-RLC-7247-2N

Titan T6 - Box Core

The Titan T6 box core is 84 5/16" tall and available from 24" to 72" wide, with levelers having 1" of adjustment. The unit is floor mounted for wall or island configurations. The box core has components such as: shelving, cantilever frame, structural cantilever table, and suspended cabinets. All components attaching to the core are ordered separately. Electrical, data or plumbing services are available in lower fixed and reagent panels.

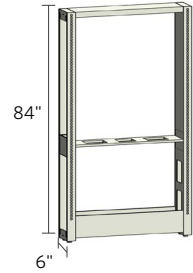

T6 BOX CORE LOAD RATINGS

Parts	Loading Rate
Top Shelf	100lbs
Shelving	200lbs
Hanging Cabinet	300lbs
Upper Hanging Cabinet	300lbs
Structural Cantilevered Table Frame	800lbs
Total Core Assembly	2,500lbs

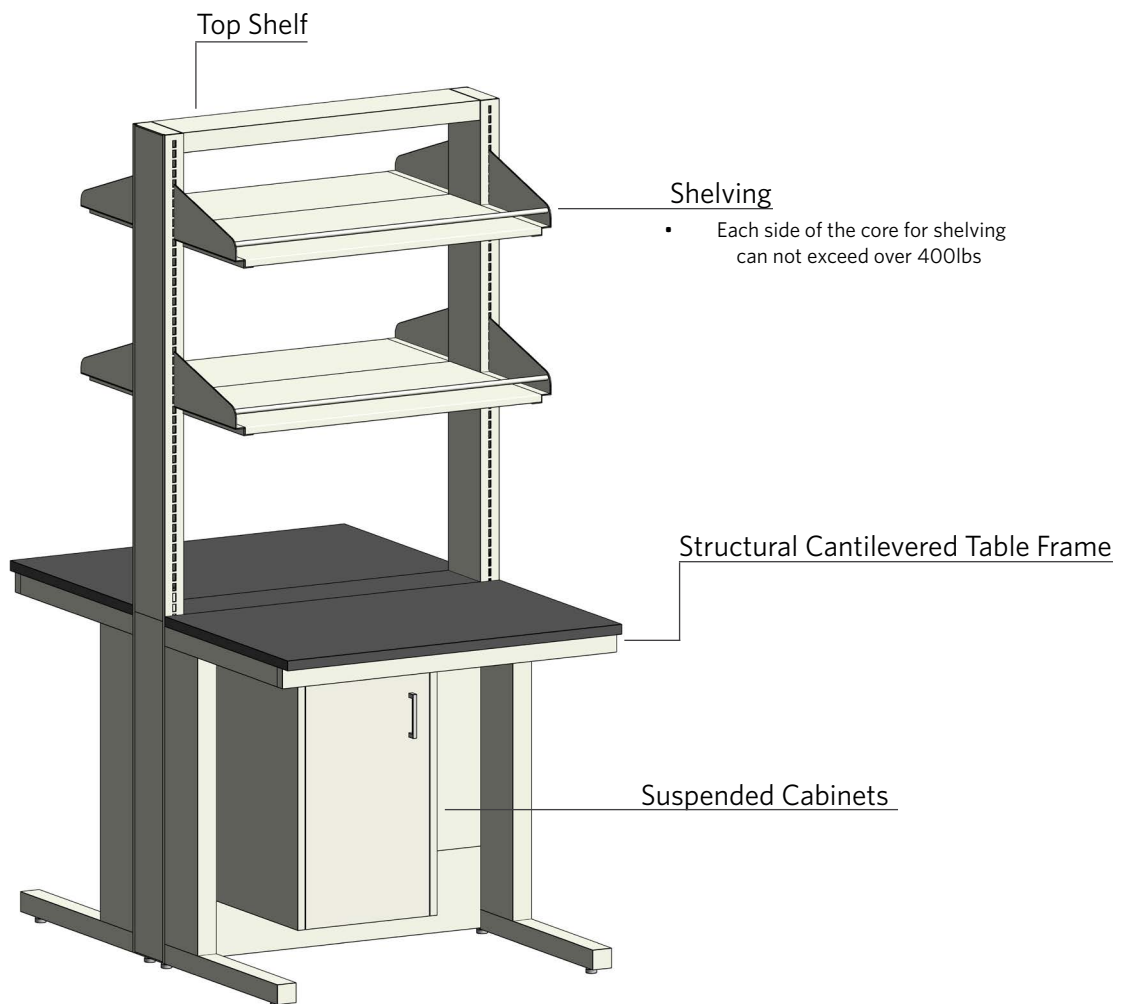

Titan T6 — Box Core

Style Height Top

Example: T6-BC-3084-ON

Titan 6" Core Width Panels

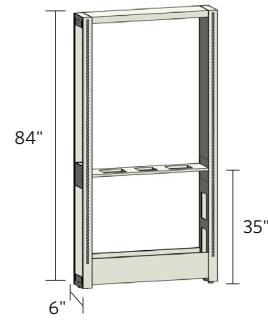

6" DEPTH BOX CORE - FULL HEIGHT

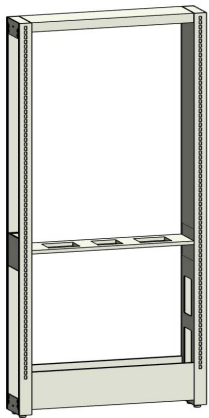

No Lower Removable Panels

Width	Item Number
24"	T6-BC-2484-ON
30"	T6-BC-3084-ON
36"	T6-BC-3684-ON
42"	T6-BC-4284-ON
48"	T6-BC-4884-ON
54"	T6-BC-5484-ON
60"	T6-BC-6084-ON
66"	T6-BC-6684-ON
72"	T6-BC-7284-ON

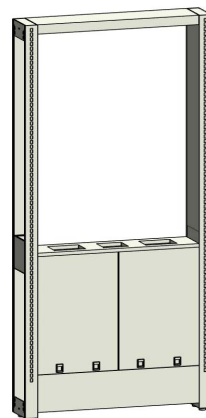

With Lower Removable Panels

Width	Item Number
24"	T6-BC-2484-2N
30"	T6-BC-3084-2N
36"	T6-BC-3684-2N
42"	T6-BC-4284-2N
48"	T6-BC-4884-2N
54"	T6-BC-5484-2N
60"	T6-BC-6084-2N
66"	T6-BC-6684-2N
72"	T6-BC-7284-2N

9" DEPTH REAGENT BOX CORE - FULL HEIGHT

The reagent box core is featuring a 12" tall reagent panel.

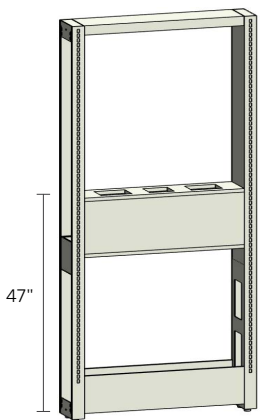

No Lower Removable Panels

Width	Item Number
24"	T6-RBC-2484-ON
30"	T6-RBC-3084-ON
36"	T6-RBC-3684-ON
42"	T6-RBC-4284-ON
48"	T6-RBC-4884-ON
54"	T6-RBC-5484-ON
60"	T6-RBC-6084-ON
66"	T6-RBC-6684-ON
72"	T6-RBC-7284-ON

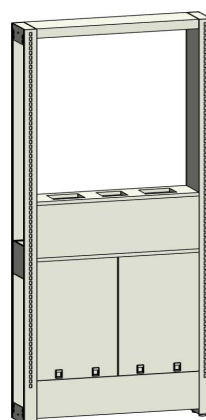

With Lower Removable Panels

Width	Item Number
24"	T6-RBC-2484-2N
30"	T6-RBC-3084-2N
36"	T6-RBC-3684-2N
42"	T6-RBC-4284-2N
48"	T6-RBC-4884-2N
54"	T6-RBC-5484-2N
60"	T6-RBC-6084-2N
66"	T6-RBC-6684-2N
72"	T6-RBC-7284-2N

Titan T6 — Lower Box Core

The Titan T6 lower box core is 35 or 47" tall and available from 24" to 72" wide, with levelers having 1" of adjustment. The unit is floor mounted for wall or island configurations. The lower box core has components such as: shelving, cantilever frame, structural cantilever table, and suspended cabinets. All components attaching to the core are ordered separately. Electrical, data or plumbing services are available in lower fixed and reagent panels.

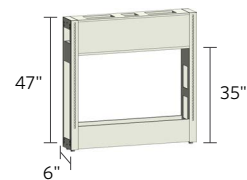

6" DEPTH BOX CORE - LOWER HEIGHT

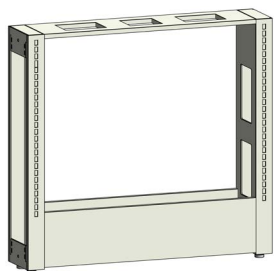

No Lower Removable Panels

Width	Item Number
24"	T6-LC-2435-0N
30"	T6-LC-3035-0N
36"	T6-LC-3635-0N
42"	T6-LC-4235-0N
48"	T6-LC-4835-0N
54"	T6-LC-5435-0N
60"	T6-LC-6035-0N
66"	T6-LC-6635-0N
72"	T6-LC-7235-0N

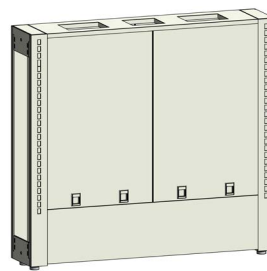

With Lower Removable Panels

Width	Item Number
24"	T6-LC-2435-2N
30"	T6-LC-3035-2N
36"	T6-LC-3635-2N
42"	T6-LC-4235-2N
48"	T6-LC-4835-2N
54"	T6-LC-5435-2N
60"	T6-LC-6035-2N
66"	T6-LC-6635-2N
72"	T6-LC-7235-2N

6" DEPTH REAGENT BOX CORE - LOWER HEIGHT

The reagent box core is featuring a 12" tall reagent panel.

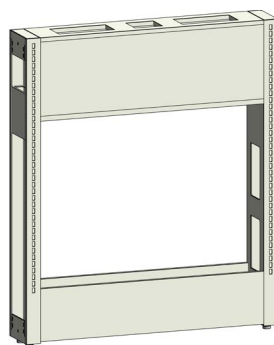

No Lower Removable Panels

Width	Item Number
24"	T6-RLC-2447-0N
30"	T6-RLC-3047-0N
36"	T6-RLC-3647-0N
42"	T6-RLC-4247-0N
48"	T6-RLC-4847-0N
54"	T6-RLC-5447-0N
60"	T6-RLC-6047-0N
66"	T6-RLC-6647-0N
72"	T6-RLC-7247-0N

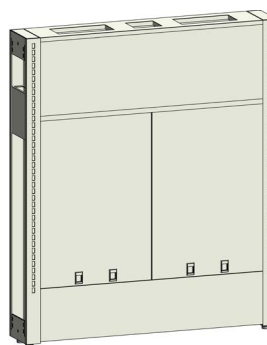

With Lower Removable Panels

Width	Item Number
24"	T6-RLC-2447-2N
30"	T6-RLC-3047-2N
36"	T6-RLC-3647-2N
42"	T6-RLC-4247-2N
48"	T6-RLC-4847-2N
54"	T6-RLC-5447-2N
60"	T6-RLC-6047-2N
66"	T6-RLC-6647-2N
72"	T6-RLC-7247-2N

Titan T3 - Box Core

The Titan T3 box core is 84 5/16" tall and available from 24" to 72" wide, with levelers having 1" of adjustment. The unit is floor mounted for wall or island configurations. The box core has components such as: shelving, cantilever frame, structural cantilever table, and suspended cabinets. All components attaching to the core are ordered separately. Electrical, data or plumbing services are available in lower fixed and reagent panels.

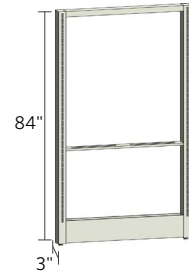

T3 BOX CORE LOAD RATINGS

Parts	Loading Rate
Shelving	180lbs
Hanging Cabinet	300lbs
Upper Hanging Cabinet	300lbs
Structural Cantilevered Table Frame	800lbs
Total Core Assembly	1,520lbs

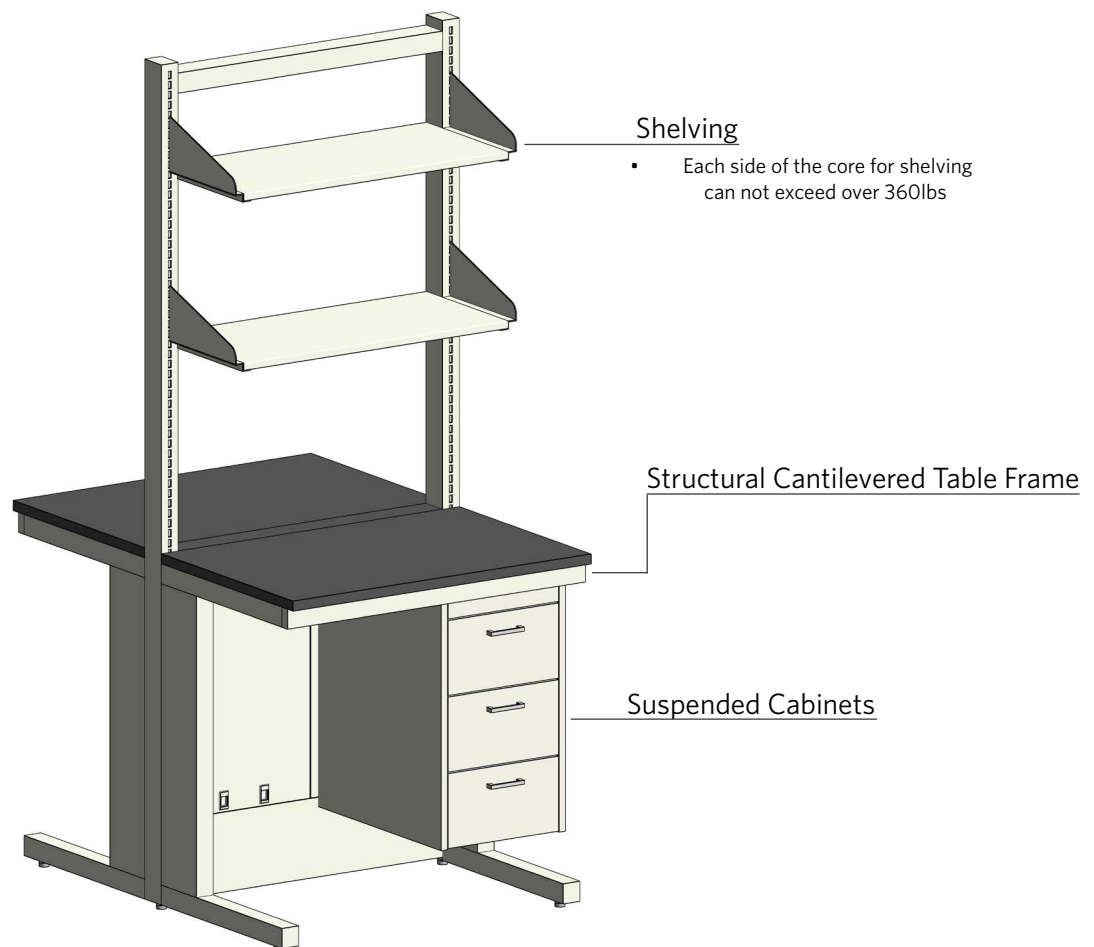

Titan T3 — Island Panel Box Core

Style
Height
Top
Example: T9-BC-3084-ON
Titan 9" Core
Width
Panels

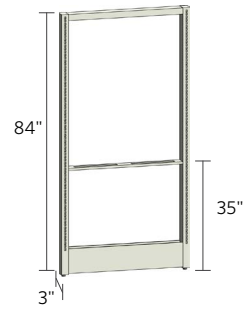

3" DEPTH BOX CORE - FULL HEIGHT

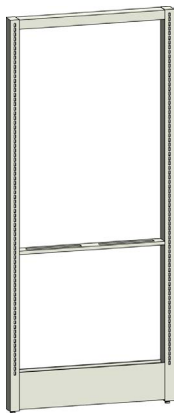

No Lower Removable Panels

Width	Item Number
24"	T3-IPBC-2484-ON
30"	T3-IPBC-3084-ON
36"	T3-IPBC-3684-ON
42"	T3-IPBC-4284-ON
48"	T3-IPBC-4884-ON
54"	T3-IPBC-5484-ON
60"	T3-IPBC-6084-ON
66"	T3-IPBC-6684-ON
72"	T3-IPBC-7284-ON

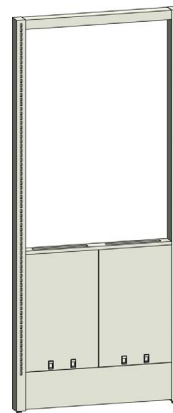

With Lower Removable Panels

Width	Item Number
24"	T3-IPBC-2484-2N
30"	T3-IPBC-3084-2N
36"	T3-IPBC-3684-2N
42"	T3-IPBC-4284-2N
48"	T3-IPBC-4884-2N
54"	T3-IPBC-5484-2N
60"	T3-IPBC-6084-2N
66"	T3-IPBC-6684-2N
72"	T3-IPBC-7284-2N

3" DEPTH REAGENT BOX CORE - FULL HEIGHT

The reagent box core is featuring a 12" tall reagent panel.

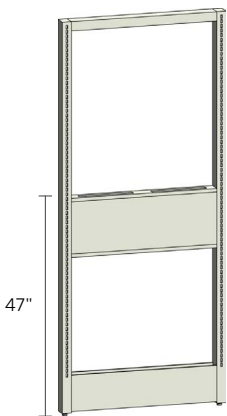

No Lower Removable Panels

Width	Item Number
24"	T3-IPRBC-2484-ON
30"	T3-IPRBC-3084-ON
36"	T3-IPRBC-3684-ON
42"	T3-IPRBC-4284-ON
48"	T3-IPRBC-4884-ON
54"	T3-IPRBC-5484-ON
60"	T3-IPRBC-6084-ON
66"	T3-IPRBC-6684-ON
72"	T3-IPRBC-7284-ON

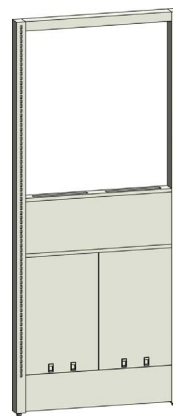

With Lower Removable Panels

Width	Item Number
24"	T3-IPRBC-2484-2N
30"	T3-IPRBC-3084-2N
36"	T3-IPRBC-3684-2N
42"	T3-IPRBC-4284-2N
48"	T3-IPRBC-4884-2N
54"	T3-IPRBC-5484-2N
60"	T3-IPRBC-6084-2N
66"	T3-IPRBC-6684-2N
72"	T3-IPRBC-7284-2N

Titan T3 — Island Panel Lower Box Core

The Titan T3 lower island box core is 35 or 47" tall and available from 24" to 72" wide, with levelers having 1" of adjustment. The unit is floor mounted for wall or island configurations. The lower box core has components such as: shelving, cantilever frame, structural cantilever table, and suspended cabinets. All components attaching to the core are ordered separately. Electrical, data or plumbing services are available in lower fixed and reagent panels.

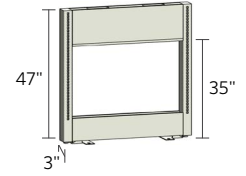

3" DEPTH BOX CORE - LOWER HEIGHT

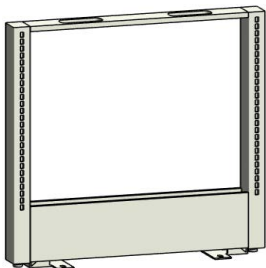

No Lower Removable Panels

Width	Item Number
24"	T3-IPLC-2435-0N
30"	T3-IPLC-3035-0N
36"	T3-IPLC-3635-0N
42"	T3-IPLC-4235-0N
48"	T3-IPLC-4835-0N
54"	T3-IPLC-5435-0N
60"	T3-IPLC-6035-0N
66"	T3-IPLC-6635-0N
72"	T3-IPLC-7235-0N

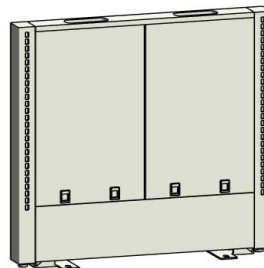

With Lower Removable Panels

Width	Item Number
24"	T3-IPLC-2435-2N
30"	T3-IPLC-3035-2N
36"	T3-IPLC-36352N
42"	T3-IPLC-4235-2N
48"	T3-IPLC-4835-2N
54"	T3-IPLC-5435-2N
60"	T3-IPLC-6035-2N
66"	T3-IPLC-66352N
72"	T3-IPLC-7235-2N

3" DEPTH REAGENT BOX CORE - FULL HEIGHT

The reagent box core is featuring a 12" tall reagent panel.

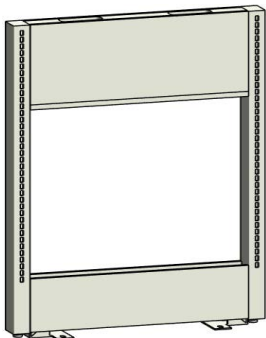

No Lower Removable Panels

Width	Item Number
24"	T3-IPRLC-2447-0N
30"	T3-IPRLC-3047-0N
36"	T3-IPRLC-3647-0N
42"	T3-IPRLC-4247-0N
48"	T3-IPRLC-4847-0N
54"	T3-IPRLC-5447-0N
60"	T3-IPRLC-6047-0N
66"	T3-IPRLC-6647-0N
72"	T3-IPRLC-7247-0N

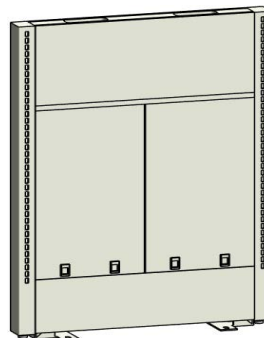

With Lower Removable Panels

Width	Item Number
24"	T3-IPRLC-2447-2N
30"	T3-IPRLC-3047-2N
36"	T3-IPRLC-3647-2N
42"	T3-IPRLC-4247-2N
48"	T3-IPRLC-4847-2N
54"	T3-IPRLC-5447-2N
60"	T3-IPRLC-6047-2N
66"	T3-IPRLC-6647-2N
72"	T3-IPRLC-7247-2N

Titan T3 — Wall Panel Box Core

The Titan T3 wall panel box core is 84 5/16" tall and available from 24" to 72" wide, with levelers having 1" of adjustment. The unit is floor mounted for wall configurations. The box core has components such as: shelving, cantilever frame, structural cantilever table, and suspended cabinets. All components attaching to the core are ordered separately. Electrical, data or plumbing services are available in lower fixed and reagent panels.

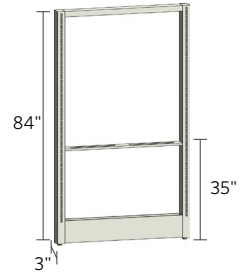

3" DEPTH BOX CORE - FULL HEIGHT



No Lower Removable Panels

Width	Item Number
24"	T3-WPBC-2484-0N
30"	T3-WPBC-3084-0N
36"	T3-WPBC-3684-0N
42"	T3-WPBC-4284-0N
48"	T3-WPBC-4884-0N
54"	T3-WPBC-5484-0N
60"	T3-WPBC-6084-0N
66"	T3-WPBC-6684-0N
72"	T3-WPBC-7284-0N

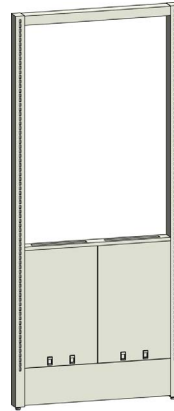

With Lower Removable Panels

Width	Item Number
24"	T3-WPBC-2484-1N
30"	T3-WPBC-3084-1N
36"	T3-WPBC-3684-1N
42"	T3-WPBC-4284-1N
48"	T3-WPBC-4884-1N
54"	T3-WPBC-5484-1N
60"	T3-WPBC-6084-1N
66"	T3-WPBC-6684-1N
72"	T3-WPBC-7284-1N

3" DEPTH REAGENT BOX CORE - FULL HEIGHT

The reagent box core is featuring a 12" tall reagent panel.

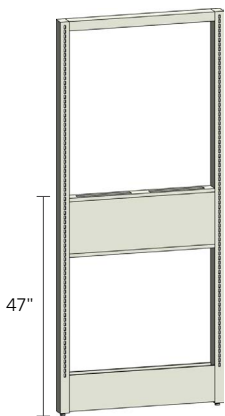

No Lower Removable Panels

Width	Item Number
24"	T3-WPRBC-2484-0N
30"	T3-WPRBC-3084-0N
36"	T3-WPRBC-3684-0N
42"	T3-WPRBC-4284-0N
48"	T3-WPRBC-4884-0N
54"	T3-WPRBC-5484-0N
60"	T3-WPRBC-6084-0N
66"	T3-WPRBC-6684-0N
72"	T3-WPRBC-7284-0N

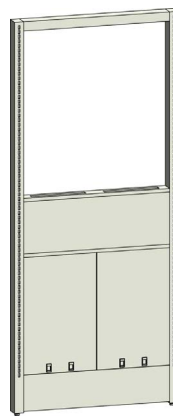

With Lower Removable Panels

Width	Item Number
24"	T3-WPRBC-2484-1N
30"	T3-WPRBC-3084-1N
36"	T3-WPRBC-3684-1N
42"	T3-WPRBC-4284-1N
48"	T3-WPRBC-4884-1N
54"	T3-WPRBC-5484-1N
60"	T3-WPRBC-6084-1N
66"	T3-WPRBC-6684-1N
72"	T3-WPRBC-7284-1N

Titan T3 — Wall Panel Lower Box Core

The Titan T3 wall panel lower box core is 35 or 47" tall and available 24" to 72" wide with levelers having 1" of adjustment. The unit is floor mounted for wall configurations. The lower box core has components such as: shelving, cantilever frame, structural cantilever table, and suspended cabinets. All components attaching to the core are ordered separately. Electrical, data or plumbing services are available in lower fixed and reagent panels.

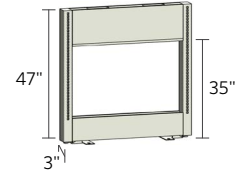

3" DEPTH BOX CORE - LOWER HEIGHT

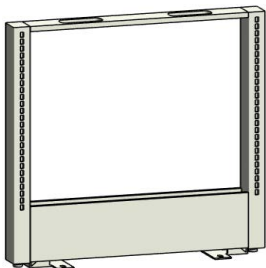

No Lower Removable Panels

Width	Item Number
24"	T3-WPLC-2435-ON
30"	T3-WPLC-3035-ON
36"	T3-WPLC-3635-ON
42"	T3-WPLC-4235-ON
48"	T3-WPLC-4835-ON
54"	T3-WPLC-5435-ON
60"	T3-WPLC-6035-ON
66"	T3-WPLC-6635-ON
72"	T3-WPLC-7235-ON

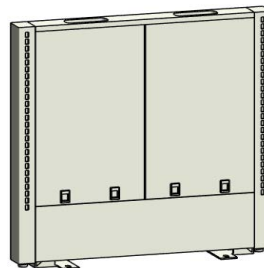

With Lower Removable Panels

Width	Item Number
24"	T3-WPLC-2435-1N
30"	T3-WPLC-3035-1N
36"	T3-WPLC-3635-1N
42"	T3-WPLC-4235-1N
48"	T3-WPLC-4835-1N
54"	T3-WPLC-5435-1N
60"	T3-WPLC-6035-1N
66"	T3-WPLC-6635-1N
72"	T3-WPLC-7235-1N

3" DEPTH REAGENT BOX CORE - FULL HEIGHT

The reagent box core is featuring a 12" tall reagent panel.

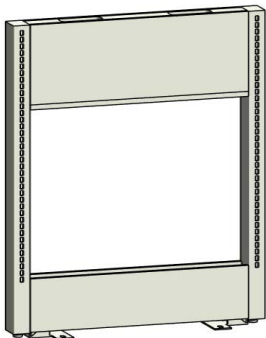

No Lower Removable Panels

Width	Item Number
24"	T3-WPRLC-2447-ON
30"	T3-WPRLC-3047-ON
36"	T3-WPRLC-3647-ON
42"	T3-WPRLC-4247-ON
48"	T3-WPRLC-4847-ON
54"	T3-WPRLC-5447-ON
60"	T3-WPRLC-6047-ON
66"	T3-WPRLC-6647-ON
72"	T3-WPRLC-7247-ON

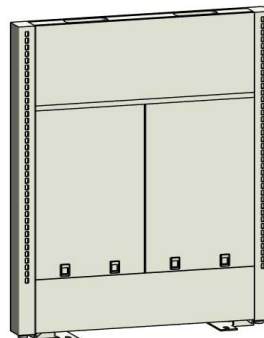

With Lower Removable Panels

Width	Item Number
24"	T3-WPRLC-2447-1N
30"	T3-WPRLC-3047-1N
36"	T3-WPRLC-3647-1N
42"	T3-WPRLC-4247-1N
48"	T3-WPRLC-4847-1N
54"	T3-WPRLC-5447-1N
60"	T3-WPRLC-6047-1N
66"	T3-WPRLC-6647-1N
72"	T3-WPRLC-7247-1N

Titan T3 — Island Shelf System

The Titan T3 island upright system is designed for 2 shelf brackets to fit into 1 upright. The intent of the design is for shelving in an island assembly.

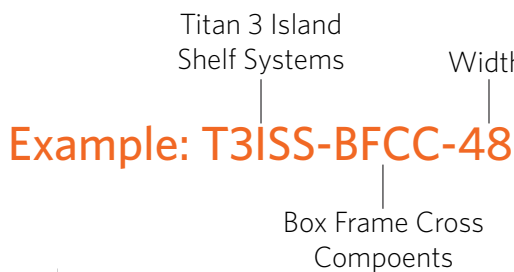

T3 ISLAND SHELF SYSTEM

Parts	Loading Rate
Shelving	180lbs
Maximum Per Side	240lbs
Total Island Assembly	480lbs

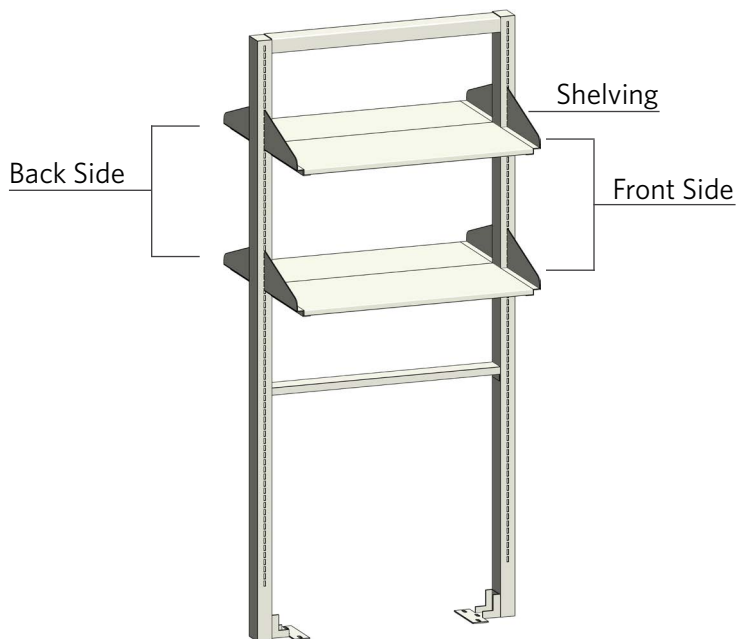

Middle Support Height	Item Number
29"	T3ISS-U84-29
35"	T3ISS-U84-35



Width	Item Number
24"	T3ISS-BFCC-24
30"	T3ISS-BFCC-30
36"	T3ISS-BFCC-36
42"	T3ISS-BFCC-42
48"	T3ISS-BFCC-48
54"	T3ISS-BFCC-54
60"	T3ISS-BFCC-60
66"	T3ISS-BFCC-66
72"	T3ISS-BFCC-72



BFCC Kits include top, middle support, and two anchoring brackets.

Titan Box Frame

The Titan T12 box frames are 48" tall and available from 24" to 72" wide. The frame allows for use of vertical space above work surface. Box frames are easily bolted to counter top. Shelving and wall can be used with Titan cores with uprights. Slotted uprights with 1" increments allow for height adjustment cabinets or shelving. T9 unit is designed for use when the casework is against the wall. This unit has the same specifications as the T12 Box Frame above except it is 9" deep. This unit is a single sided unit Side panels to cover the space between uprights can be ordered separately and services can be run through them. All the components are ordered separately.

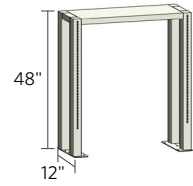

TITAN BOX FRAME ASSEMBLY

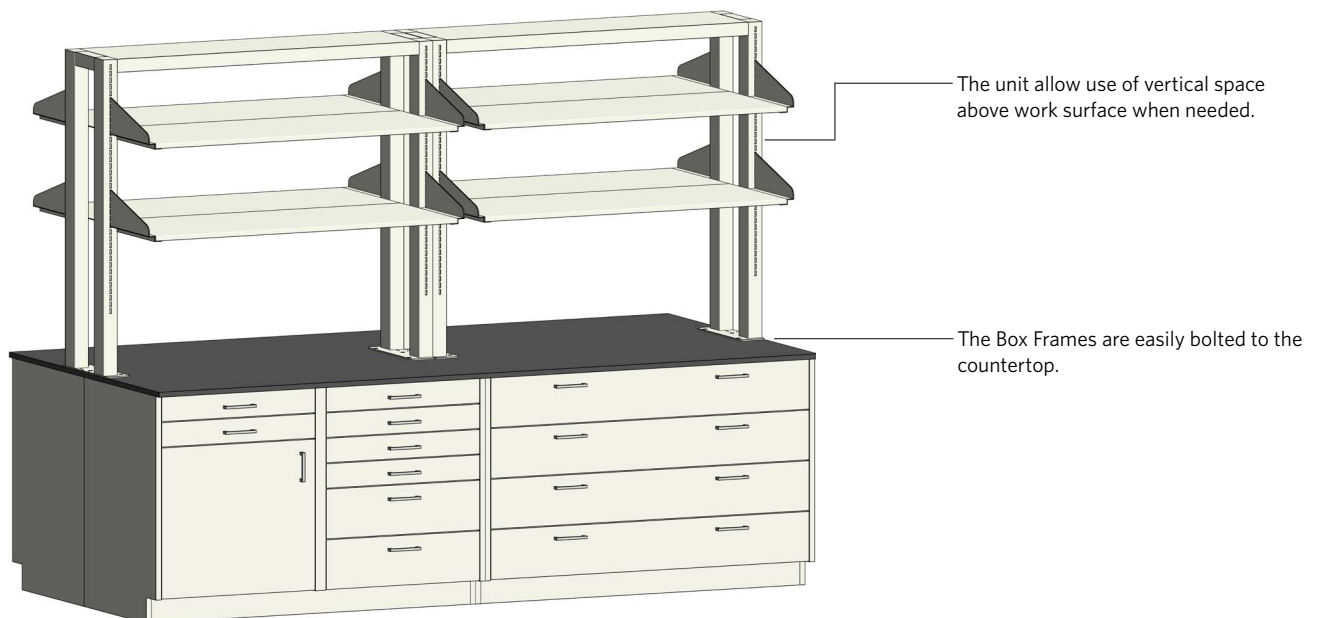

The shelving and wall storage used with Titan cores works with box frame uprights.

There are slotted uprights with 1" increments to allow height adjustment with cabinets and shelves.

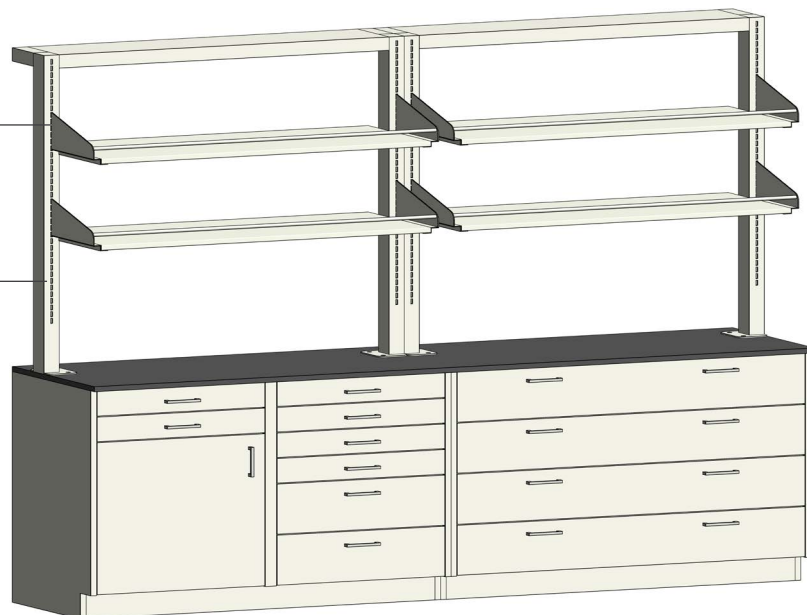

Titan Box Frame

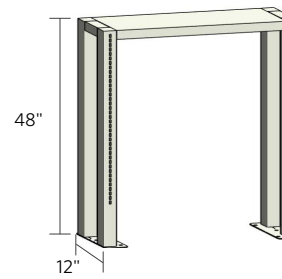
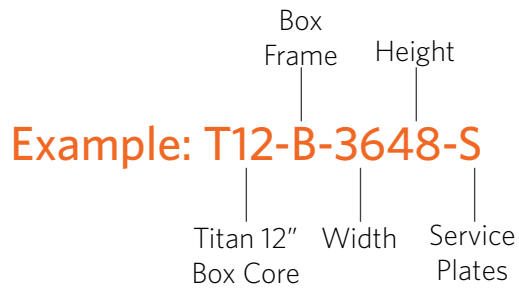

12" DEPTH BOX FRAME COUNTER MOUNT

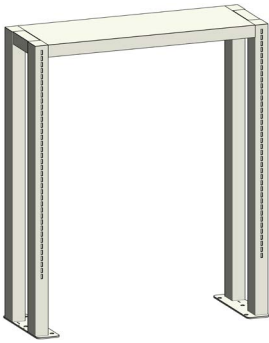

Width	Item Number
24"	T12-B-2448
30"	T12-B-3048
36"	T12-B-3648
42"	T12-B-4248
48"	T12-B-4848
54"	T12-B-5448
60"	T12-B-6048
66"	T12-B-6648
72"	T12-B-7248

9" DEPTH WALL BOX FRAME COUNTER MOUNT

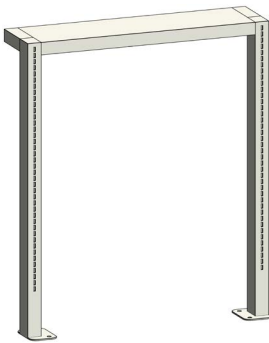

Width	Item Number
24"	T9-B-2448
30"	T9-B-3048
36"	T9-B-3648
42"	T9-B-4248
48"	T9-B-4848
54"	T9-B-5448
60"	T9-B-6048
66"	T9-B-6648
72"	T9-B-7248

3" DEPTH BOX FRAME COUNTER MOUNT

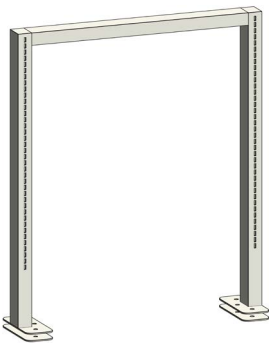

Width	Item Number
24"	T3-B-2448
30"	T3-B-3048
36"	T3-B-3648
42"	T3-B-4248
48"	T3-B-4848
54"	T3-B-5448
60"	T3-B-6048
66"	T3-B-6648
72"	T3-B-7248

Titan Box Frame Shared

Allows use of vertical space above work surface when needed. Box frames are easily bolted to counter top. Slotted uprights for shelving with 1" increments. Side panels to cover the space between uprights can be ordered separately for services to be run through them. Both the single uprights and cross members must be ordered at the same time to create a complete Titan Shared Upright Shelf kits must be ordered separately.

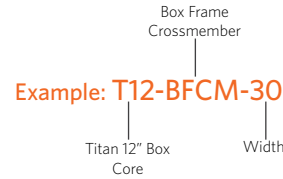
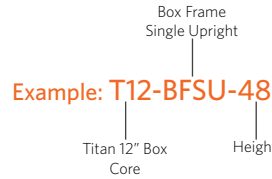
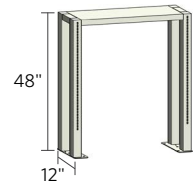

12" SHARED BOX FRAME

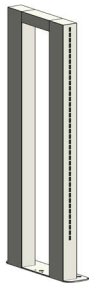

Height	Item Number
48"	T12-BFSU-48

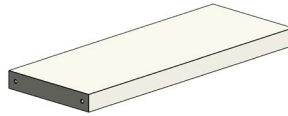
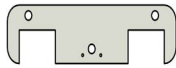

Width	Item Number
24"	T12-BFCM-24
30"	T12-BFCM-30
36"	T12-BFCM-36
42"	T12-BFCM-42
48"	T12-BFCM-48
54"	T12-BFCM-54
60"	T12-BFCM-60
66"	T12-BFCM-66
72"	T12-BFCM-72

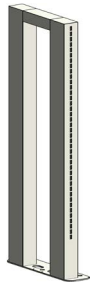

Height	Item Number
48"	T12-BFSU-48-S

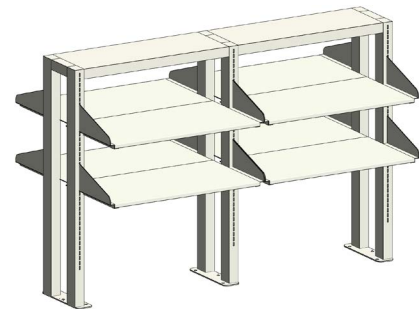

3" SHARED BOX FRAME

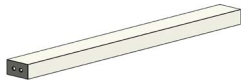

Width	Item Number
24"	T3-BFCM-24
30"	T3-BFCM-30
36"	T3-BFCM-36
42"	T3-BFCM-42
48"	T3-BFCM-48
54"	T3-BFCM-54
60"	T3-BFCM-60
66"	T3-BFCM-66
72"	T3-BFCM-72

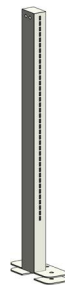

Height	Item Number
48"	T3-BFSU-48

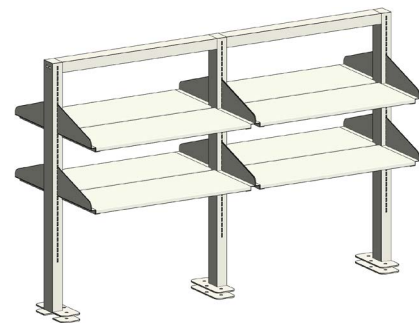

Titan Side Removable Panels

Optional side panels are 18 gauge CRS Side panels to cover the space between uprights can be ordered separately and services can be run through them.

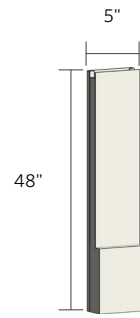
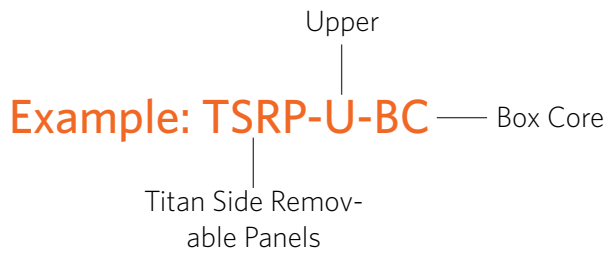

UPPER PANELS

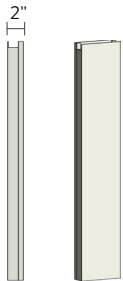

Item Number
TSRP-U-BC
Use With
T12
T9

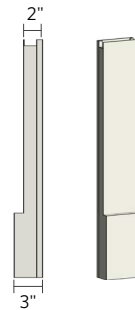

Item Number
TSRP-U-BC-12LP
Use With
T12
T9

Recommended when services needed.



Item Number
T6-LPA-84U
Use With
T6



Item Number
T6-UPA-84U
Use With
T6

LOWER PANELS

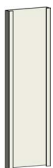

Item Number
TSRP-L
Use With
T12
T9



Item Number
TSRP-M
Use With
T12
T9

BOX FRAME PANELS

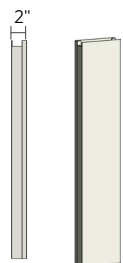

Item Number
TSRP-BF-48
Use With
Box Frame

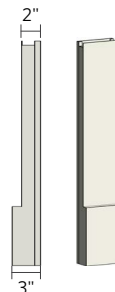

Item Number
TSRP-BF-48-12LP
Use With
Box Frame

Recommended when services needed.

Titan Shelf Kit

Titan shelving come in four different styles. There are Bookend (B), Inverted (U), Seismic Rod (SR), and Inner (I). The shelves will fit in any Titan Core, Titan Box Frames, Titan Work Benches, and Titan Mobile Carts. Kit widths should match the width of the unit it is paired with. Standard depth kits Shelves are the same depth as brackets and set with flush mount uprights Extended depth kits Shelves are deeper than the brackets and extended to the back. We offer 1", 3", and 6" extended shelf kits.

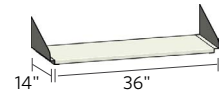

STANDARD DEPTH KITS

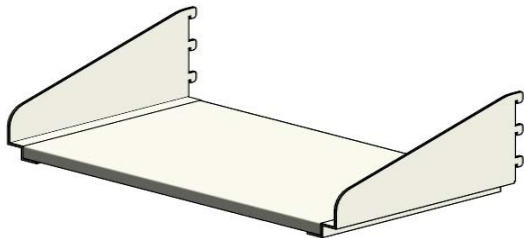

Width	12" Brackets	14" Brackets	16" Brackets	18" Brackets
24"	TSK-1224-12B	TSK-1424-14B	TSK-1624-16B	TSK-1824-18B
30"	TSK-1230-12B	TSK-1430-14B	TSK-1630-16B	TSK-1830-18B
36"	TSK-1236-12B	TSK-1436-14B	TSK-1636-16B	TSK-1836-18B
42"	TSK-1242-12B	TSK-1442-14B	TSK-1642-16B	TSK-1842-18B
48"	TSK-1248-12B	TSK-1448-14B	TSK-1648-16B	TSK-1848-18B
54"	TSK-1254-12B	TSK-1454-14B	TSK-1654-16B	TSK-1854-18B
60"	TSK-1260-12B	TSK-1460-14B	TSK-1660-16B	TSK-1860-18B
66"	TSK-1266-12B	TSK-1466-14B	TSK-1666-16B	TSK-1866-18B
72"	TSK-1272-12B	TSK-1472-14B	TSK-1672-16B	TSK-1872-18B

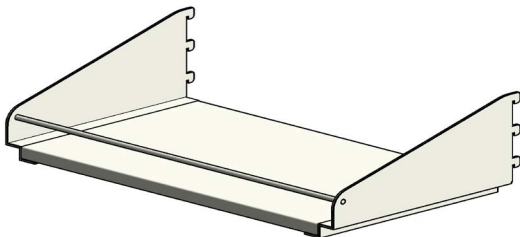

Width	12" Brackets	14" Brackets	16" Brackets	18" Brackets
24"	TSK-1224-12SR	TSK-1424-14SR	TSK-1624-16SR	TSK-1824-18SR
30"	TSK-1230-12SR	TSK-1430-14SR	TSK-1630-16SR	TSK-1830-18SR
36"	TSK-1236-12SR	TSK-1436-14SR	TSK-1636-16SR	TSK-1836-18SR
42"	TSK-1242-12SR	TSK-1442-14SR	TSK-1642-16SR	TSK-1842-18SR
48"	TSK-1248-12SR	TSK-1448-14SR	TSK-1648-16SR	TSK-1848-18SR
54"	TSK-1254-12SR	TSK-1454-14SR	TSK-1654-16SR	TSK-1854-18SR
60"	TSK-1260-12SR	TSK-1460-14SR	TSK-1660-16SR	TSK-1860-18SR
66"	TSK-1266-12SR	TSK-1466-14SR	TSK-1666-16SR	TSK-1866-18SR
72"	TSK-1272-12SR	TSK-1472-14SR	TSK-1672-16SR	TSK-1872-18SR

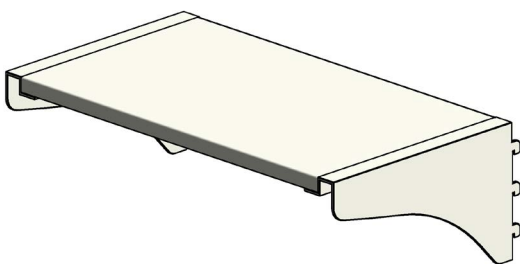

Width	12" Brackets	14" Brackets	16" Brackets	18" Brackets
24"	TSK-1224-12U	TSK-1424-14U	TSK-1624-16U	TSK-1824-18U
30"	TSK-1230-12U	TSK-1430-14U	TSK-1630-16U	TSK-1830-18U
36"	TSK-1236-12U	TSK-1436-14U	TSK-1636-16U	TSK-1836-18U
42"	TSK-1242-12U	TSK-1442-14U	TSK-1642-16U	TSK-1842-18U
48"	TSK-1248-12U	TSK-1448-14U	TSK-1648-16U	TSK-1848-18U
54"	TSK-1254-12U	TSK-1454-14U	TSK-1654-16U	TSK-1854-18U
60"	TSK-1260-12U	TSK-1460-14U	TSK-1660-16U	TSK-1860-18U
66"	TSK-1266-12U	TSK-1466-14U	TSK-1666-16U	TSK-1866-18U
72"	TSK-1272-12U	TSK-1472-14U	TSK-1672-16U	TSK-1872-18U

Titan Shelf Kits

Titan extended shelf kits come in four different styles. There are Bookend (B), Inverted (U), and Seismic Rod (SR). The brackets will fit in any Titan Core, Titan Box Frame, Titan Work Bench, and Titan Mobile Cart. Kit widths should match the width of the unit it is paired with. We offer 1", 3", and 6" extended shelf kits.

EXTENDED DEPTH KITS

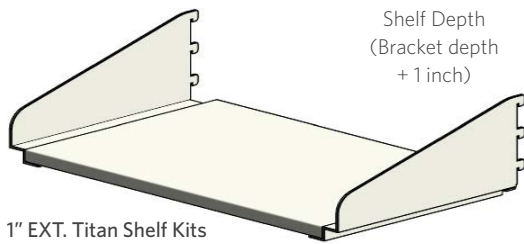

Width	12" Brackets	14" Brackets	16" Brackets	18" Brackets
24"	TSK-1324-12B	TSK-1524-14B	TSK-1724-16B	TSK-1924-18B
30"	TSK-1330-12B	TSK-1530-14B	TSK-1730-16B	TSK-1930-18B
36"	TSK-1336-12B	TSK-1536-14B	TSK-1736-16B	TSK-1936-18B
42"	TSK-1342-12B	TSK-1542-14B	TSK-1742-16B	TSK-1942-18B
48"	TSK-1348-12B	TSK-1548-14B	TSK-1748-16B	TSK-1948-18B
54"	TSK-1354-12B	TSK-1554-14B	TSK-1754-16B	TSK-1954-18B
60"	TSK-1360-12B	TSK-1560-14B	TSK-1760-16B	TSK-1960-18B
66"	TSK-1366-12B	TSK-1566-14B	TSK-1766-16B	TSK-1966-18B
72"	TSK-1372-12B	TSK-1572-14B	TSK-1772-16B	TSK-1972-18B

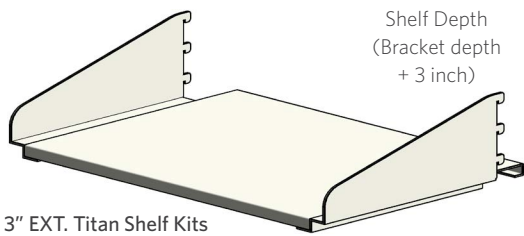

Width	12" Brackets	14" Brackets	16" Brackets	18" Brackets
24"	TSK-1524-12B	TSK-1724-14B	TSK-1924-16B	TSK-2124-18B
30"	TSK-1530-12B	TSK-1730-14B	TSK-1930-16B	TSK-2130-18B
36"	TSK-1536-12B	TSK-1736-14B	TSK-1936-16B	TSK-2136-18B
42"	TSK-1542-12B	TSK-1742-14B	TSK-1942-16B	TSK-2142-18B
48"	TSK-1548-12B	TSK-1748-14B	TSK-1948-16B	TSK-2148-18B
54"	TSK-1554-12B	TSK-1754-14B	TSK-1954-16B	TSK-2154-18B
60"	TSK-1560-12B	TSK-1760-14B	TSK-1960-16B	TSK-2160-18B
66"	TSK-1566-12B	TSK-1766-14B	TSK-1966-16B	TSK-2166-18B
72"	TSK-1572-12B	TSK-1772-14B	TSK-1972-16B	TSK-2172-18B

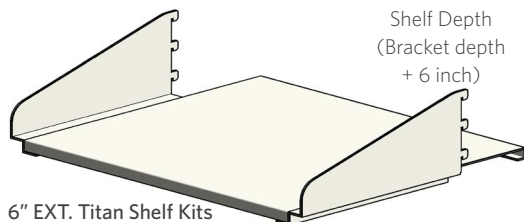

Width	12" Brackets	14" Brackets	16" Brackets	18" Brackets
24"	TSK-1824-12B	TSK-2024-14B	TSK-2224-16B	TSK-2424-18B
30"	TSK-1830-12B	TSK-2030-14B	TSK-2230-16B	TSK-2430-18B
36"	TSK-1836-12B	TSK-2036-14B	TSK-2236-16B	TSK-2436-18B
42"	TSK-1842-12B	TSK-2042-14B	TSK-2242-16B	TSK-2442-18B
48"	TSK-1848-12B	TSK-2048-14B	TSK-2248-16B	TSK-2448-18B
54"	TSK-1854-12B	TSK-2054-14B	TSK-2254-16B	TSK-2454-18B
60"	TSK-1860-12B	TSK-2060-14B	TSK-2260-16B	TSK-2460-18B
66"	TSK-1866-12B	TSK-2066-14B	TSK-2266-16B	TSK-2466-18B
72"	TSK-1872-12B	TSK-2072-14B	TSK-2272-16B	TSK-2472-18B

Titan Shelf Kits

Titan brackets come in three different styles. There are bookend, inverted and inner shelf designs.

STANDARD BRACKET KITS

Includes left and right when ordered.

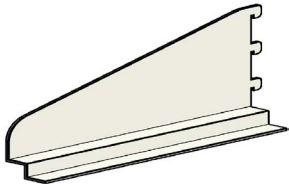

Width	Brackets
12"	SE-12
14"	SE-14
16"	SE-16
18"	SE-18

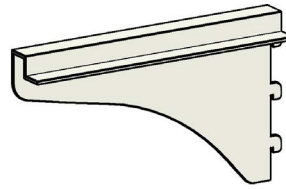

Width	Brackets
12"	SEU-12
14"	SEU-14
16"	SEU-16
18"	SEU-18

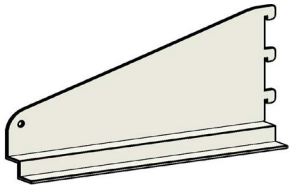

Width	Brackets
12"	SE-12-SR
14"	SE-14-SR
16"	SE-16-SR
18"	SE-18-SR

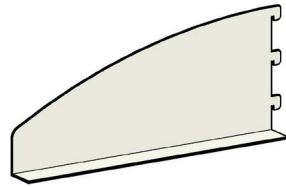

Width	Brackets
12"	LSE-12
14"	LSE-14
16"	LSE-16
18"	LSE-18

INNER SHELF KITS

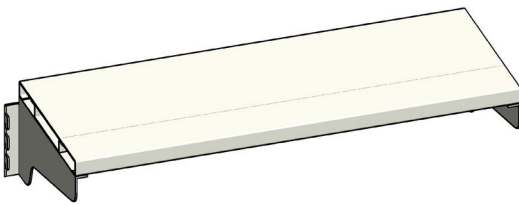

Width	For 12" BOX CORE	For 9" BOX CORE
24"	TSK-1224-12I	TSK-924-9I
30"	TSK-1230-12I	TSK-930-9I
36"	TSK-1236-12I	TSK-936-9I
42"	TSK-1242-12I	TSK-942-9I
48"	TSK-1248-12I	TSK-948-9I
54"	TSK-1254-12I	TSK-954-9I
60"	TSK-1260-12I	TSK-960-9I
66"	TSK-1266-12I	TSK-966-9I
72"	TSK-1272-12I	TSK-972-9I

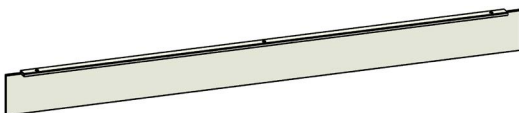

1" High Shelf Lips (Fits Front or Back 1")
Front / Back Lip

Lip Width	Item Number	Use With
22"	FLIP22	24" W TSK
28"	FLIP28	30" W TSK
34"	FLIP34	36" W TSK
40"	FLIP40	42" W TSK
46"	FLIP46	48" W TSK
52"	FLIP52	54" W TSK
58"	FLIP58	60" W TSK

Cantilever Table Frame

Cantilever table frames are an essential component setting a titan configuration in your lab. The frames are constructed in 14 gauge steel, come in two different styles. Structural cantilever table and cantilever table. Both tables will support up to 800lbs loaded evenly. The structural support table frames (SCTF) attach directly to the core, allowing it to support the Island or wall cores. This setup is ideal when cores cannot be anchored to the floor. The table has a fixed height of 29" or 35". The cantilever table frames (CTF) attach directly to the bolted core and is adjustable in one inch increments. Both frames can support suspended cabinets.

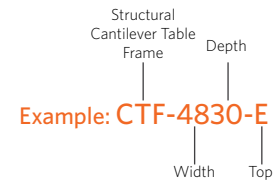
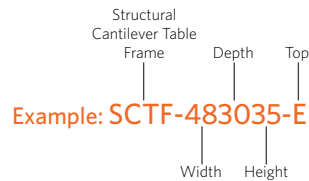
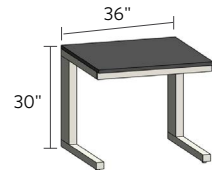

STRUCTURAL CANTILEVER TABLE FRAME

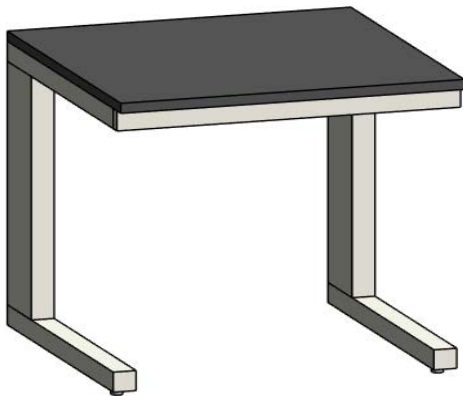

Width	Item Number	Item Number	Item Number	Item Number
24"	SCTF-242429	SCTF-242435	SCTF-243029	SCTF-243035
30"	SCTF-302429	SCTF-302435	SCTF-303029	SCTF-303035
36"	SCTF-362429	SCTF-362435	SCTF-363029	SCTF-363035
42"	SCTF-422429	SCTF-422435	SCTF-423029	SCTF-423035
48"	SCTF-482429	SCTF-482435	SCTF-483029	SCTF-483035
54"	SCTF-542429	SCTF-542435	SCTF-543029	SCTF-543035
60"	SCTF-602429	SCTF-602435	SCTF-603029	SCTF-603035
66"	SCTF-662429	SCTF-662435	SCTF-663029	SCTF-663035
72"	SCTF-722429	SCTF-722435	SCTF-723029	SCTF-723035

CANTILEVER FRAME

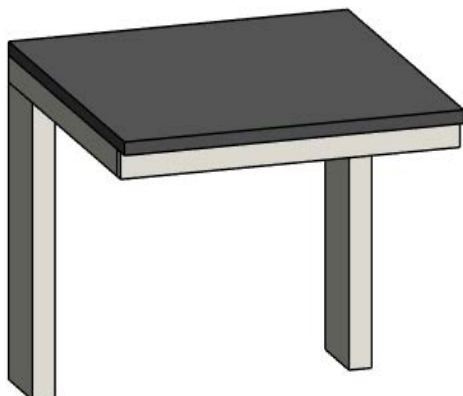

Width	Item Number	Item Number
24"	CTF-2424	CTF-2430
30"	CTF-3024	CTF-3030
36"	CTF-3624	CTF-3630
42"	CTF-4224	CTF-4230
48"	CTF-4824	CTF-4830
54"	CTF-5424	CTF-5430
60"	CTF-6024	CTF-6030
66"	CTF-6624	CTF-6630
72"	CTF-7224	CTF-7230

Wall Rails System

The wall rail system is installed in applications where there may not be backing to support standards and only shelving will be installed. With a 1" profile, heights of 24", 30", 36", 42" and widths from 24-72", this system is very flexible to change shelf widths in the future. Proper blocking required for horizontal rails. Wall shelf kit ordered separately (See page 31).

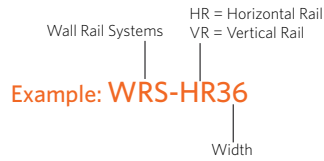
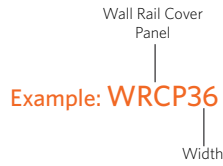
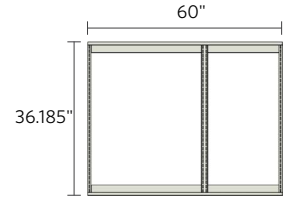

WALL RAIL SYSTEM LOAD RATINGS

Parts	Loading Rate
Shelving with Bracket Depth 12 and 14	200lbs
Shelving with Bracket Depth 16 and 18	160lbs
Maximum Per Section	400lbs

For shelving only. If cabinets or cantilever frames are required, use our heavy duty wall rail system (page 32).

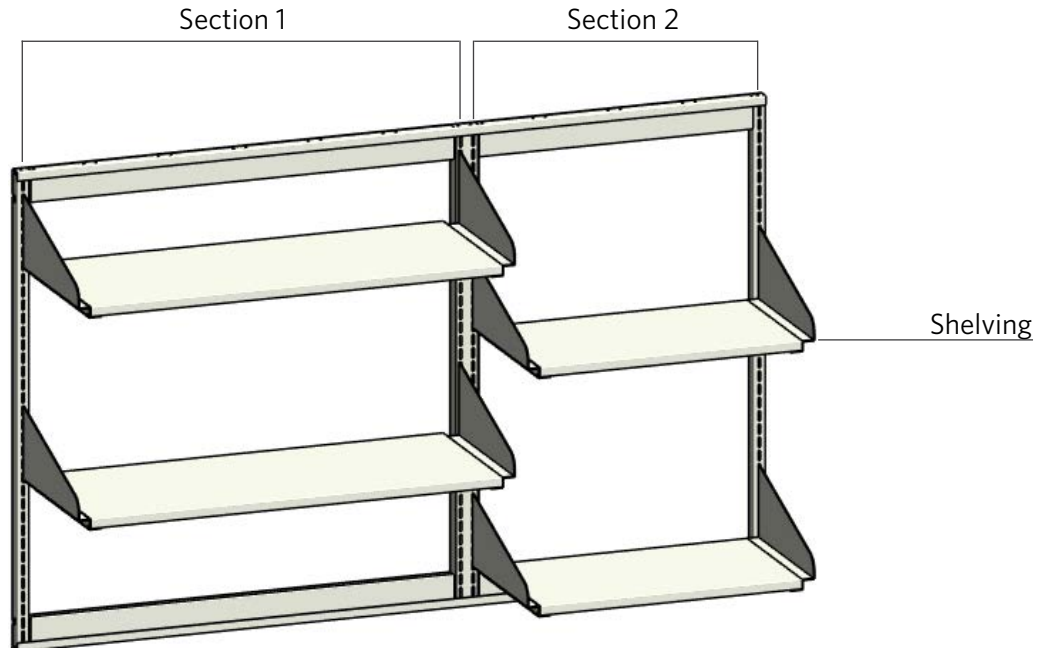

Wall Rails System

How To Order: By Components

- WRS-VR36 (2)
- WRS-HR60 (2)
- WRS-VRDS36 (1)
- WRCP36 (2)
- WRCP24 (2)

SHELVES SHOW
 TWSK-1336-12B (2)
 TWSK-1224-12B (2)

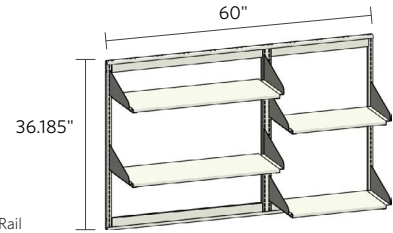

WALL RAIL SYSTEM

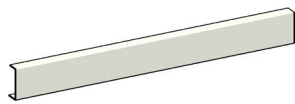

Cover Panel

Width	Item Number
24"	WRCP24
30"	WRCP30
36"	WRCP36
42"	WRCP42
48"	WRCP48
54"	WRCP54
60"	WRCP60
66"	WRCP66
72"	WRCP72



Horizontal Rail

Width	Item Number
24"	WRS-HR24
30"	WRS-HR30
36"	WRS-HR36
42"	WRS-HR42
48"	WRS-HR48
54"	WRS-HR54
60"	WRS-HR60
66"	WRS-HR66
72"	WRS-HR72



Vertical Rail

Height	Item Number
24"	WRS-VR24
30"	WRS-VR30
36"	WRS-VR36
42"	WRS-VR42
48"	WRS-VR48



Vertical Double Slotted Rail

Height	Item Number
24"	WRS-VRDS24
30"	WRS-VRDS30
36"	WRS-VRDS36
42"	WRS-VRDS42
48"	WRS-VRDS48

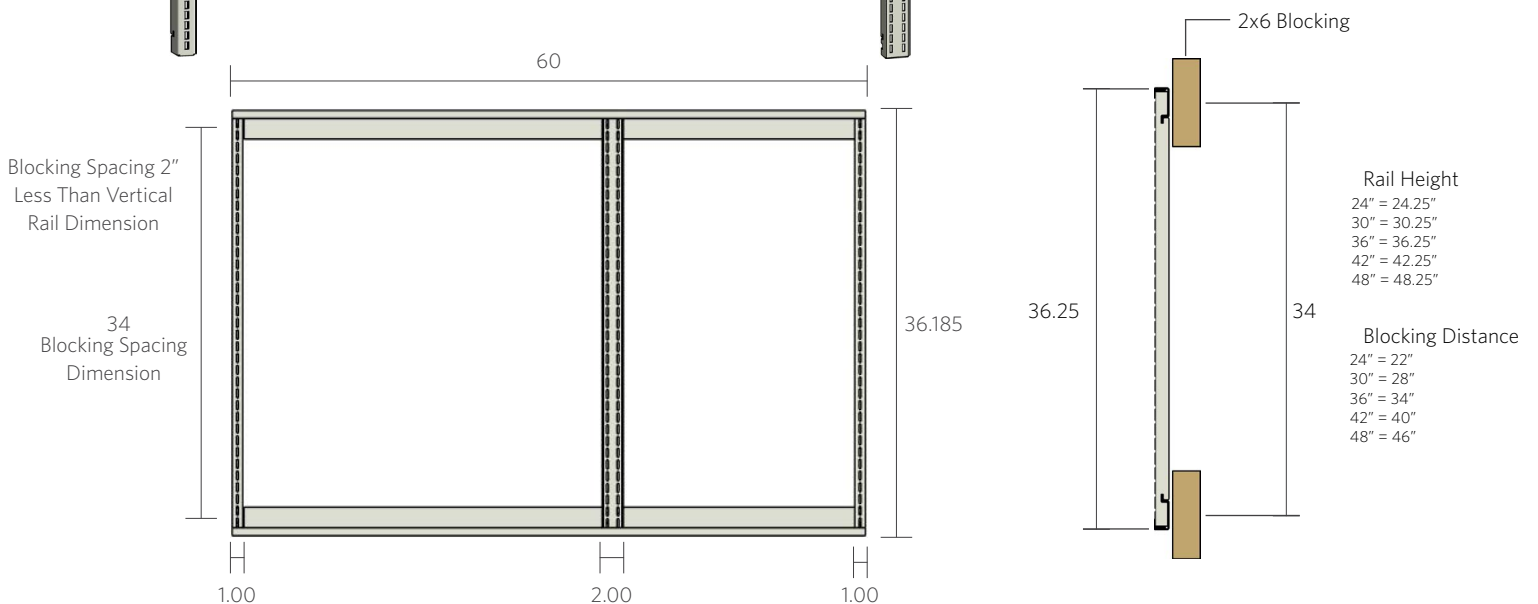

Standard Titan Wall Shelf Kits

* TWSK Only use with wall rail system.

STANDARD TITAN WALL SHELF KITS

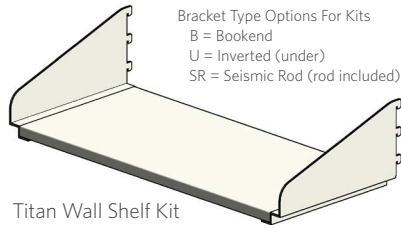

Titan Wall Shelf Kit

TWSK-1230-12B

Width	12" Brackets	14" Brackets	16" Brackets
24"	TWSK-1224-12B	TWSK-1424-14B	TWSK-1624-16B
30"	TWSK-1230-12B	TWSK-1430-14B	TWSK-1630-16B
36"	TWSK-1236-12B	TWSK-1436-14B	TWSK-1636-16B
42"	TWSK-1242-12B	TWSK-1442-14B	TWSK-1642-16B
48"	TWSK-1248-12B	TWSK-1448-14B	TWSK-1648-16B
54"	TWSK-1254-12B	TWSK-1454-14B	TWSK-1654-16B
60"	TWSK-1260-12B	TWSK-1460-14B	TWSK-1660-16B
66"	TWSK-1266-12B	TWSK-1466-14B	TWSK-1666-16B
72"	TWSK-1272-12B	TWSK-1472-14B	TWSK-1672-16B



Titan Wall Shelf Kit

TWSK-1330-12B

Width	12" Brackets	14" Brackets	16" Brackets
24"	TWSK-1324-12B	TWSK-1524-14B	TWSK-1724-16B
30"	TWSK-1330-12B	TWSK-1530-14B	TWSK-1730-16B
36"	TWSK-1336-12B	TWSK-1536-14B	TWSK-1736-16B
42"	TWSK-1342-12B	TWSK-1542-14B	TWSK-1742-16B
48"	TWSK-1348-12B	TWSK-1548-14B	TWSK-1748-16B
54"	TWSK-1354-12B	TWSK-1554-14B	TWSK-1754-16B
60"	TWSK-1360-12B	TWSK-1560-14B	TWSK-1760-16B
66"	TWSK-1366-12B	TWSK-1566-14B	TWSK-1766-16B
72"	TWSK-1372-12B	TWSK-1572-14B	TWSK-1772-16B

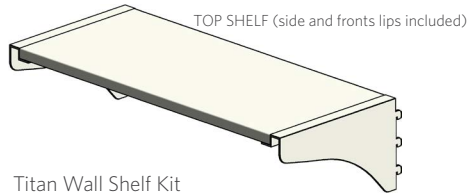

Titan Wall Shelf Kit

TWSK-TOP-1230-12U

Width	12" Brackets	14" Brackets	16" Brackets
24"	TWSK-TOP-1224-12U	TWSK-TOP-1424-14U	TWSK-TOP-1624-16U
30"	TWSK-TOP-1230-12U	TWSK-TOP-1430-14U	TWSK-TOP-1630-16U
36"	TWSK-TOP-1236-12U	TWSK-TOP-1436-14U	TWSK-TOP-1636-16U
42"	TWSK-TOP-1242-12U	TWSK-TOP-1442-14U	TWSK-TOP-1642-16U
48"	TWSK-TOP-1248-12U	TWSK-TOP-1448-14U	TWSK-TOP-1648-16U
54"	TWSK-TOP-1254-12U	TWSK-TOP-1454-14U	TWSK-TOP-1654-16U
60"	TWSK-TOP-1260-12U	TWSK-TOP-1460-14U	TWSK-TOP-1660-16U
66"	TWSK-TOP-1266-12U	TWSK-TOP-1466-14U	TWSK-TOP-1666-16U
72"	TWSK-TOP-1272-12U	TWSK-TOP-1472-14U	TWSK-TOP-1672-16U

1" High Shelf Lips (Fits Fronts or Back 1")

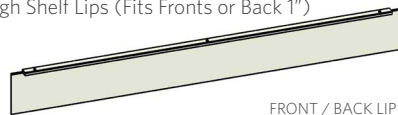

FLIP35

Lip Width	Item Number	Use With
22"	FLIP23	24" W TWSK
28"	FLIP29	30" W TWSK
34"	FLIP35	36" W TWSK
40"	FLIP41	42" W TWSK
46"	FLIP47	48" W TWSK
52"	FLIP53	54" W TWSK
58"	FLIP59	60" W TWSK

Wall Standards

Wall standards are the least expensive way to install shelving for a wall. It requires full proper blocking along the whole standard to assure they able to hold the weight on the shelves.

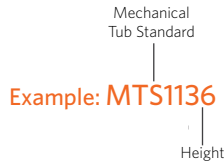
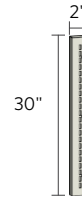

WALL STANDARDS



Height	Item Number
24"	MTS1124
30"	MTS1130
36"	MTS1136
42"	MTS1142
48"	MTS1148
72"	MTS1172

WALL STANDARD SHELF KITS

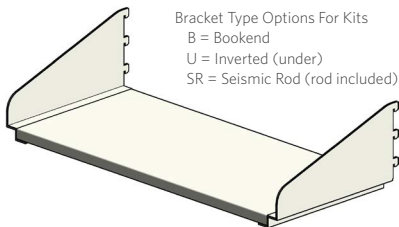

WSK-1230-12B

Width	12" Brackets	14" Brackets	16" Brackets
24"	WSK-1224-12B	WSK-1424-14B	WSK-1624-16B
30"	WSK-1230-12B	WSK-1430-14B	WSK-1630-16B
36"	WSK-1236-12B	WSK-1436-14B	WSK-1636-16B
42"	WSK-1242-12B	WSK-1442-14B	WSK-1642-16B
48"	WSK-1248-12B	WSK-1448-14B	WSK-1648-16B
54"	WSK-1254-12B	WSK-1454-14B	WSK-1654-16B
60"	WSK-1260-12B	WSK-1460-14B	WSK-1660-16B
66"	WSK-1266-12B	WSK-1466-14B	WSK-1666-16B
72"	WSK-1272-12B	WSK-1472-14B	WSK-1672-16B

* Only use with wall standards.

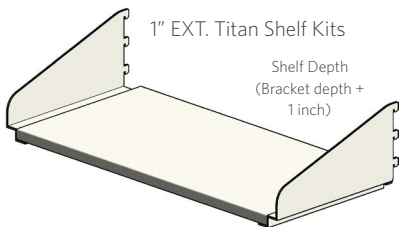

WSK-1330-12B

Width	12" Brackets	14" Brackets	16" Brackets
24"	WSK-1324-12B	WSK-1524-14B	WSK-1724-16B
30"	WSK-1330-12B	WSK-1530-14B	WSK-1730-16B
36"	WSK-1336-12B	WSK-1536-14B	WSK-1736-16B
42"	WSK-1342-12B	WSK-1542-14B	WSK-1742-16B
48"	WSK-1348-12B	WSK-1548-14B	WSK-1748-16B
54"	WSK-1354-12B	WSK-1554-14B	WSK-1754-16B
60"	WSK-1360-12B	WSK-1560-14B	WSK-1760-16B
66"	WSK-1366-12B	WSK-1566-14B	WSK-1766-16B
72"	WSK-1372-12B	WSK-1572-14B	WSK-1772-16B

Heavy Duty Wall Rails

Wall Rail HD: Heavy Duty Rails- capability to support table frames (with optional hanging cabinets) Profile: 1" deep, 2" wide vertical rails. Available heights: 24", 30", 36", 42", 48" and 78". Available widths: from 24", 30", 36", 42", 48", 54", 60", 66", 72". Proper blocking needed for horizontal rails, extra blocking required for 78" high rails. **Components to order:** -Horizontal channels (2)-Vertical Upright - Single Slotted (2 per section)-Cover Panels **Gauges**

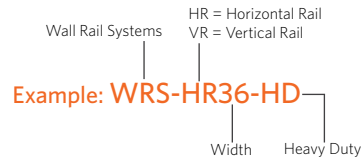
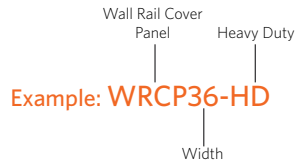
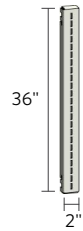

HEAVY DUTY WALL RAIL SYSTEM LOAD RATINGS

Parts	Loading Rate
Shelving with Bracket Depth 12 and 14	200lbs
Shelving with Bracket Depth 16 and 18	160lbs
Cantileverd Table Frame	400lbs
Maximum Per Section	800lbs

How To Order: By Components

- WRS-VRA78-HD (4) **SHELVES SHOWN**
TSK-1336-12B
- WRS-HR72-HD (2)
- WRCP36-HD (4) **TABLES SHOWN**
CTF-3624-N

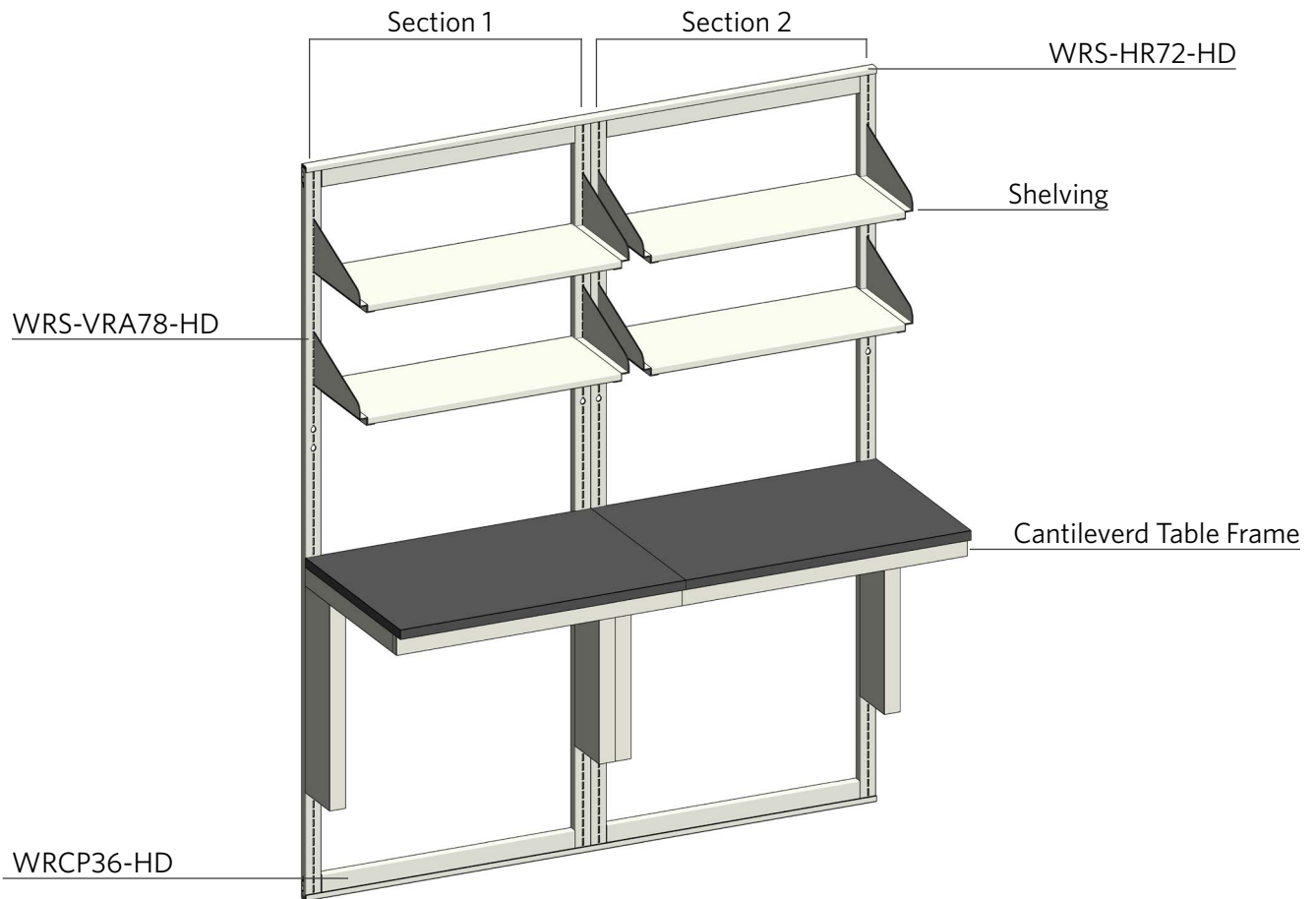

Heavy Duty Wall Rails

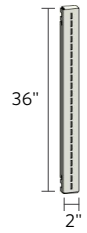
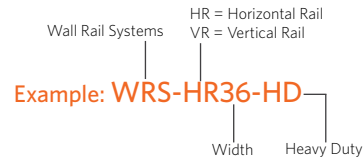
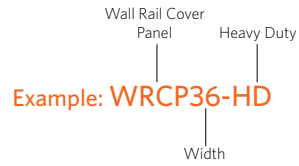

HEAVY DUTY WALL RAIL SYSTEM

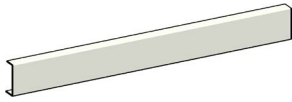

Width	Item Number
24"	WRCP24-HD
30"	WRCP30-HD
36"	WRCP36-HD
42"	WRCP42-HD
48"	WRCP48-HD
54"	WRCP54-HD
60"	WRCP60-HD
66"	WRCP66-HD
72"	WRCP72-HD



Width	Item Number
24"	WRS-HR24-HD
30"	WRS-HR30-HD
36"	WRS-HR36-HD
42"	WRS-HR42-HD
48"	WRS-HR48-HD
54"	WRS-HR54-HD
60"	WRS-HR60-HD
66"	WRS-HR66-HD
72"	WRS-HR72-HD



Height	Item Number
78"	WRS-VRA78-HD

72.00



Height	Item Number
24"	WRS-VR24-HD
30"	WRS-VR30-HD
36"	WRS-VR36-HD
42"	WRS-VR42-HD
48"	WRS-VR48-HD

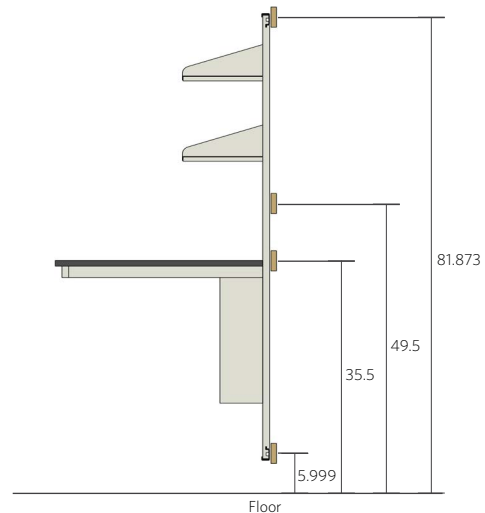
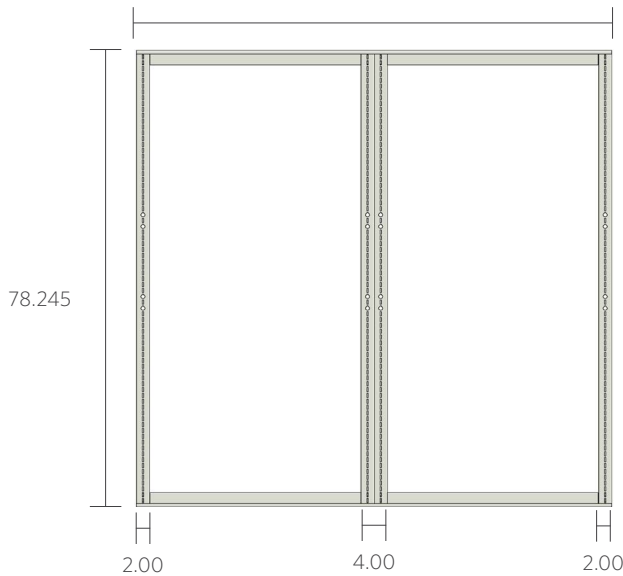

Heavy Duty Shelf Kits

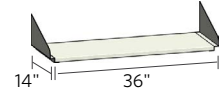

Parts	Loading Rate
Shelving with Bracket Depth 12 and 14	200lbs
Shelving with Bracket Depth 16 and 18	160lbs

HEAVY DUTY SHELF KITS

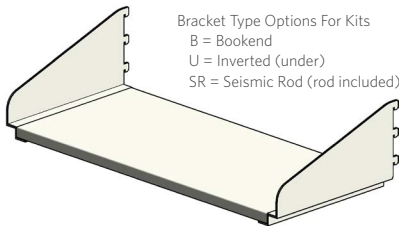

TSK-1230-12B
Titan Wall Shelf Kit

Width	12" Brackets	14" Brackets	16" Brackets	18" Brackets
24"	TSK-1224-12B	TSK-1424-14B	TSK-1624-16B	TSK-1824-18B
30"	TSK-1230-12B	TSK-1430-14B	TSK-1630-16B	TSK-1830-18B
36"	TSK-1236-12B	TSK-1436-14B	TSK-1636-16B	TSK-1836-18B
42"	TSK-1242-12B	TSK-1442-14B	TSK-1642-16B	TSK-1842-18B
48"	TSK-1248-12B	TSK-1448-14B	TSK-1648-16B	TSK-1848-18B
54"	TSK-1254-12B	TSK-1454-14B	TSK-1654-16B	TSK-1854-18B
60"	TSK-1260-12B	TSK-1460-14B	TSK-1660-16B	TSK-1860-18B
66"	TSK-1266-12B	TSK-1466-14B	TSK-1666-16B	TSK-1866-18B
72"	TSK-1272-12B	TSK-1472-14B	TSK-1672-16B	TSK-1872-18B

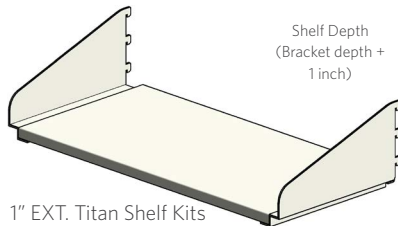

TSK-1330-12B
Titan Wall Shelf Kit

Width	12" Brackets	14" Brackets	16" Brackets	18" Brackets
24"	TSK-1324-12B	TSK-1524-14B	TSK-1724-16B	TSK-1924-18B
30"	TSK-1330-12B	TSK-1530-14B	TSK-1730-16B	TSK-1930-18B
36"	TSK-1336-12B	TSK-1536-14B	TSK-1736-16B	TSK-1936-18B
42"	TSK-1342-12B	TSK-1542-14B	TSK-1742-16B	TSK-1942-18B
48"	TSK-1348-12B	TSK-1548-14B	TSK-1748-16B	TSK-1948-18B
54"	TSK-1354-12B	TSK-1554-14B	TSK-1754-16B	TSK-1954-18B
60"	TSK-1360-12B	TSK-1560-14B	TSK-1760-16B	TSK-1960-18B
66"	TSK-1366-12B	TSK-1566-14B	TSK-1766-16B	TSK-1966-18B
72"	TSK-1372-12B	TSK-1572-14B	TSK-1772-16B	TSK-1972-18B

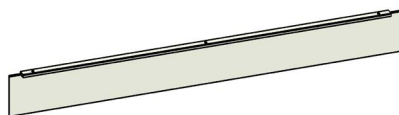

FLIP35 FRONT / BACK LIP
1" High Shelf Lips (Fits Fronts or Back 1")

Lip Width	Item Number	Use With
22"	FLIP22	24" W TWSK
28"	FLIP28	30" W TWSK
34"	FLIP34	36" W TWSK
40"	FLIP40	42" W TWSK
46"	FLIP46	48" W TWSK
52"	FLIP52	54" W TWSK
58"	FLIP58	60" W TWSK

Titan Mobile Carts

Titan Cart features fully welded cart base. Uprights are bolted into the base. Structural vertical support for the tables, cabinets (suspended & wall versions) and shelving. Frames can be ganged side by side or back to back. Equipped with 700 lbs locking casters. Levelers and a 750 lbs leveling caster are an option. Sizes Cores come in 2 standard heights: 78" and 36" high units. Widths come in 36", 48", 60", and 72". Depth is 30" Max Weight load Breakdown: Shelves 200lbs each (600lbs max). Table Frame can hold 800lbs. Bottom Shelf hold 400lbs. Mobile Cart maximum weight load 1800lbs. Look at gauge and see if you need it in the text.

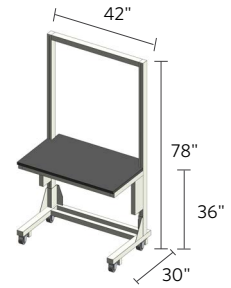

MOBILE CART LOAD RATINGS

Parts	Loading Rate
Shelving	200lbs
Cantilevered Table Work Frame	800lbs
Bottom Shelf Assembly	400lbs
Total Cart Assembly	1,600lbs



Titan Mobile Carts

C = Casters Only
 CL = Casters & Leveling Feet
 H = 550lb leveling Casters
 X = 1100lb leveling Casters

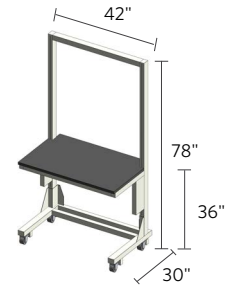

Titan Mobile Cart Depth

Example: TMC-483036-CL-MP-E

Width Height Modesty Panel E = Cantilever Table with Epoxy Top
 P = Cantilever Table with Phenolic Top
 N = No Top

MOBILE CARTS

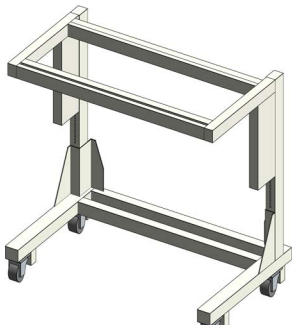

Width	Item Number
36"	TMC-363036-CL
42"	TMC-423036-CL
48"	TMC-483036-CL
60"	TMC-603036-CL
72"	TMC-723036-CL

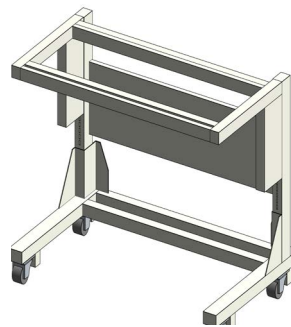

Width	Item Number
36"	TMC-363036-CL-MP
42"	TMC-423036-CL-MP
48"	TMC-483036-CL-MP
60"	TMC-603036-CL-MP
72"	TMC-723036-CL-MP

(Model shown with modesty panel)

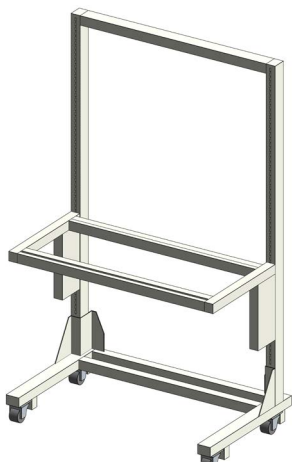

Width	Item Number
36"	TMC-363078-CL
42"	TMC-423078-CL
48"	TMC-483078-CL
60"	TMC-603078-CL
72"	TMC-723078-CL

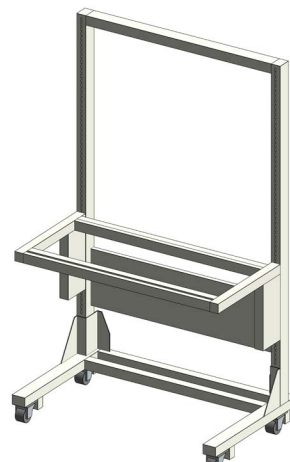

Width	Item Number
36"	TMC-363078-CL-MP
42"	TMC-423078-CL-MP
48"	TMC-483078-CL-MP
60"	TMC-603078-CL-MP
72"	TMC-723078-CL-MP

(Model shown with modesty panel)

Titan Mobile Cart Components

All TSK shelves will work with this unit. Shown on page 24.

MOBILE CART - SHELVES & WORK SURFACES

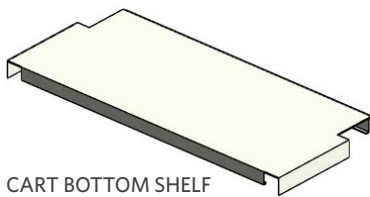

Width	Item Number (Depth 30)	Item Number (Depth 36)
36"	TMC-BSA-3630	TMC-BSA-3636
42"	TMC-BSA-4230	TMC-BSA-4236
48"	TMC-BSA-4830	TMC-BSA-4836
60"	TMC-BSA-6030	TMC-BSA-6036
72"	TMC-BSA-7230	TMC-BSA-7236

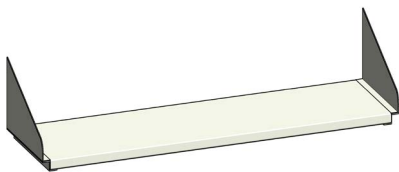

TITAN SHELF KITS
See Titan Shelf Kits on pages 24-26 for more options.

Width	12" Brackets	14" Brackets	16" Brackets	18" Brackets
24"	TSK-1224-12B	TSK-1424-14B	TSK-1624-16B	TSK-1824-18B
30"	TSK-1230-12B	TSK-1430-14B	TSK-1630-16B	TSK-1830-18B
36"	TSK-1236-12B	TSK-1436-14B	TSK-1636-16B	TSK-1836-18B
42"	TSK-1242-12B	TSK-1442-14B	TSK-1642-16B	TSK-1842-18B
48"	TSK-1248-12B	TSK-1448-14B	TSK-1648-16B	TSK-1848-18B
54"	TSK-1254-12B	TSK-1454-14B	TSK-1654-16B	TSK-1854-18B
60"	TSK-1260-12B	TSK-1460-14B	TSK-1660-16B	TSK-1860-18B
66"	TSK-1266-12B	TSK-1466-14B	TSK-1666-16B	TSK-1866-18B
72"	TSK-1272-12B	TSK-1472-14B	TSK-1672-16B	TSK-1872-18B

Heavy Duty Mobile Carts

Heavy Duty features fully welded cart base. Uprights are bolted into the base. Structural vertical support for the tables, cabinets (suspended & wall versions) and shelving. Equipped with 700 lbs locking casters. Levelers and a 1100 lbs leveling caster are an option. Sizes Cores come in 2 standard heights: 78" and 36" high units. Widths come in 36", 48", 60", and 72". Depth is 30" Max Weight load Breakdown: Shelves 600lbs each (1200lbs max) Table Frame 800lbs Bottom Shelf 600lbs Mobile Cart maximum weight load 2600lbs.

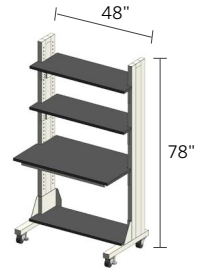

HEAVY DUTY MOBILE CART LOAD RATINGS

Parts	Loading Rate
HD Shelving	500lbs
HD Table Frame	1000lbs
HD Lower Shelf	600lbs
Total Cart Assembly	2,600lbs

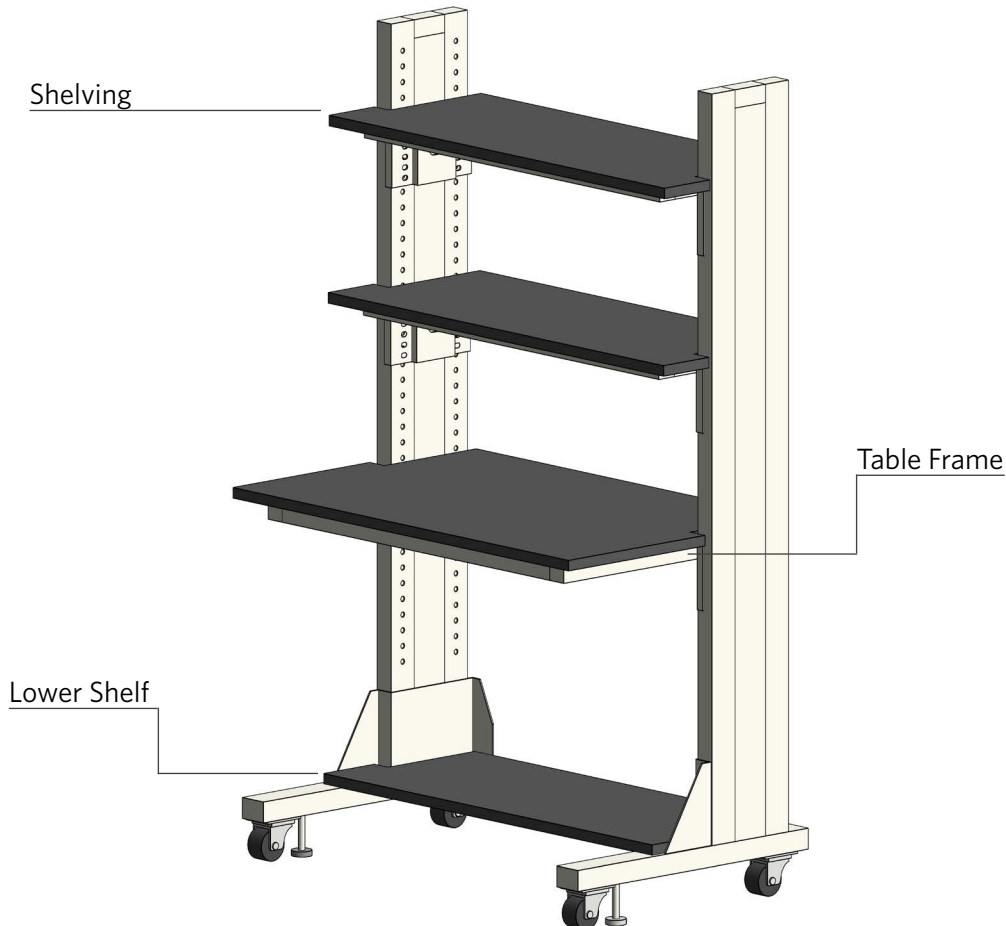

Heavy Duty Mobile Carts

Heavy Duty features fully welded cart base. Uprights are bolted into the base. Structural vertical support for the tables, cabinets (suspended & wall versions) and shelving. Frames can be ganged side by side or back to back. Equipped with 700 lbs locking casters. Levelers and a 1100 lbs leveling caster are an option. Sizes Cores come in 2 standard heights: 78" and 36" high units. Widths come in 36", 48", 60", and 72". Depth is 30" Max Weight load Breakdown: Shelves 600lbs each (1200lbs max) Table Frame 800lbs Bottom Shelf 600lbs Mobile Cart maximum weight load 2600lbs.

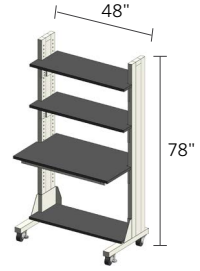

C = Casters Only
 CL = Casters & Leveling Feet
 H = 750lb leveling Casters

Heavy Duty Mobile Cart Depth Left Post
 Width Height Cable Management Right Post

Example: HDMC-483036-CL-CM-E-3E3P

Services:
 (Services must be same on each post)
 1, 2, 3 Number of Services (max 3)
 P = Plumbing
 E = Electrical
 D = Data

E = Cantilever Table with Epoxy Top
 P = Cantilever Table with Phenolic Top
 N = No Top

MOBILE CARTS



Width	Item Number
36"	HDMC-363036-CL
48"	HDMC-483036-CL
60"	HDMC-603036-CL
72"	HDMC-723036-CL

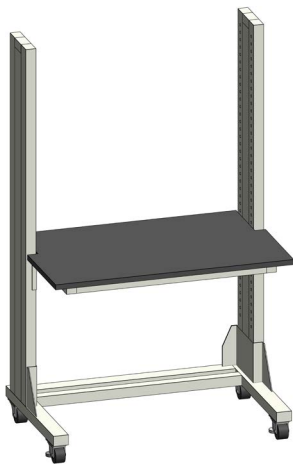

Width	Item Number
36"	HDMC-363078-CL
48"	HDMC-483078-CL
60"	HDMC-603078-CL
72"	HDMC-723078-CL

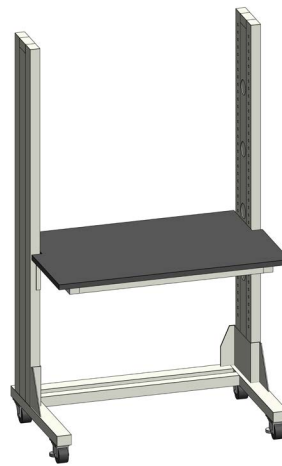

Width	Item Number
36"	HDMC-363078-CL-CM
48"	HDMC-483078-CL-CM
60"	HDMC-603078-CL-CM
72"	HDMC-723078-CL-CM

Heavy Duty Mobile Cart Components

Heavy Duty Mobile Cart

Width

Table Frame

Depth

N = No top, frame only
 E = with epoxy top
 P = with phenolic top

Example: HDMC-SF-4818-N

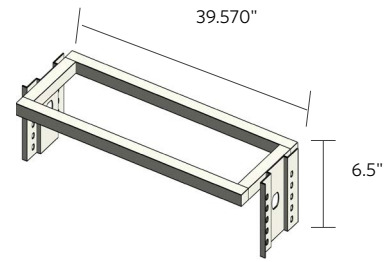

MOBILE CART - SHELVES & WORK SURFACES

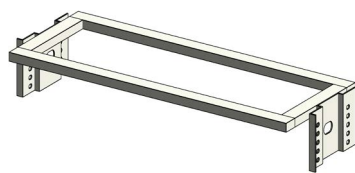
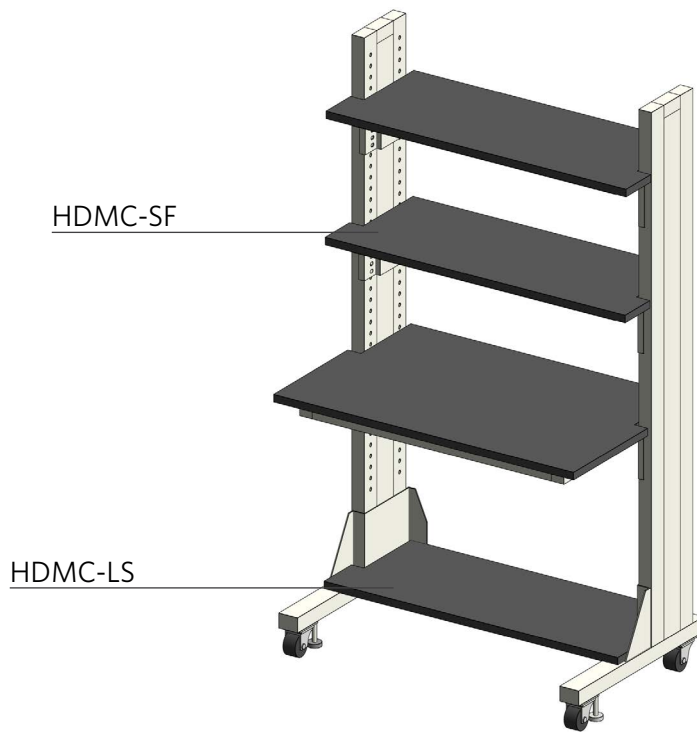

Width	Item Number
36"	HDMC-SF-3618
48"	HDMC-SF-4818
60"	HDMC-SF-6018
72"	HDMC-SF-7218

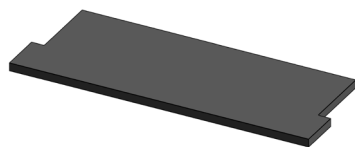

Width	Item Number
36"	HDMC-LS-3618-E
48"	HDMC-LS-4818-E
60"	HDMC-LS-6018-E
72"	HDMC-LS-7218-E

Titan Work Bench - No Services

Titan Work Bench (TWB) gives the maximum flexibility for configuring your lab. Wall and island configurations can be readily created and easily changed as well as moved for new applications or changing space. Can be used in conjunction with suspended, mobile or floor-mounted casework. Standard tables are 36" high and 30" deep. Adjustable height units range from 29-38" high. They can be fixed or adjustable in height. In this model you can have leveling feet or casters installed. The table will support up to 1,000lbs. Order WB shelving separately. Shelf brackets are adjustable in 1" increments to allow for multiple configurations. Standard shelves are 12" or 16" deep.



Titan Work Bench
Width
Depth

N = No top, frame only
E = with epoxy top
P = with phenolic top
O = Other

Example: TWB-AL4230-N

L = Leveler Feet
C = Locking Casters
H = 600# Leveling Casters
X = 1000# Leveling Casters
A = Adjustable Height
S = Stationary (Fixed Height)

TITAN WORK BENCH (NO SERVICES)



Width	Item Number
30"	TWB-AL3030-E
36"	TWB-AL3630-E
42"	TWB-AL4230-E
48"	TWB-AL4830-E
54"	TWB-AL5430-E
60"	TWB-AL6030-E
66"	TWB-AL6630-E
72"	TWB-AL7230-E

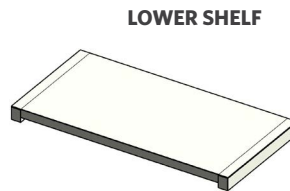

Width	Item Number
30"	TWBSHELF-3030
36"	TWBSHELF-3630
42"	TWBSHELF-4230
48"	TWBSHELF-4830
54"	TWBSHELF-5430
60"	TWBSHELF-6030
66"	TWBSHELF-6630
72"	TWBSHELF-7230

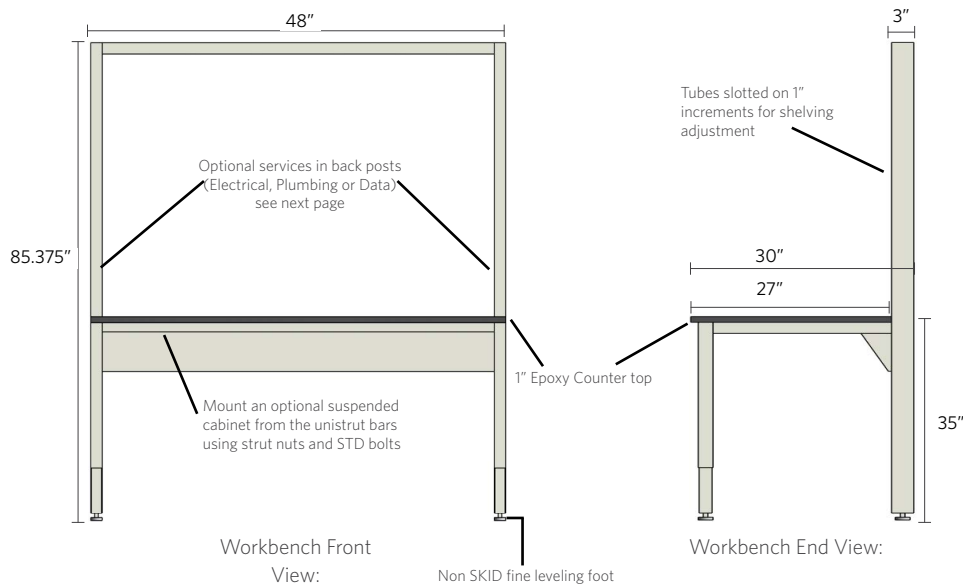

Titan Work Bench - With Services

Titan Work Bench (TWB) gives the maximum flexibility for configuring your lab. Wall and island configurations can be readily created and easily changed as well as moved for new applications or changing space. Can be used in conjunction with suspended, mobile or floor-mounted casework. Standard tables are 36" high and 30" deep. Adjustable height units range from 29-38" high. They can be fixed or adjustable in height. In this model you can have leveling feet or casters installed. The table will support up to 1,000lbs. Order WB shelving separately. Shelf brackets are adjustable in 1" increments to allow for multiple configurations. Standard shelves are 12" or 16" deep.

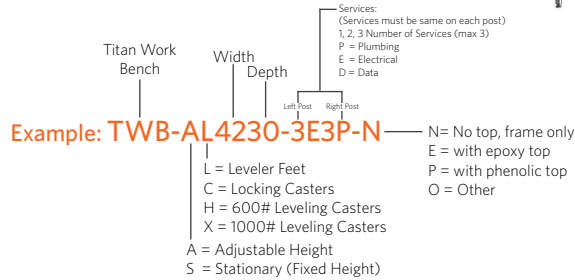
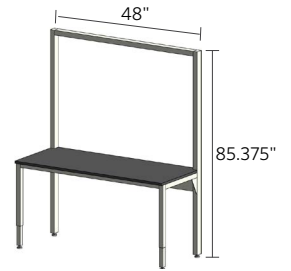

TITAN WORK BENCH (WITH SERVICES)



Width	Item Number
30"	TWB-AL3030-3E3P-E
36"	TWB-AL3630-3E3P-E
42"	TWB-AL4230-3E3P-E
48"	TWB-AL4830-3E3P-E
54"	TWB-AL5430-3E3P-E
60"	TWB-AL6030-3E3P-E
66"	TWB-AL6630-3E3P-E
72"	TWB-AL7230-3E3P-E

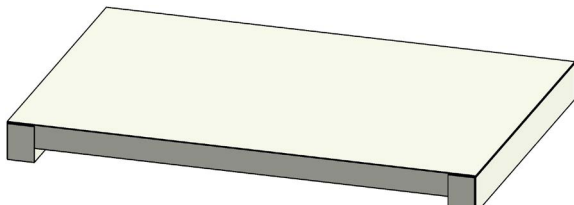

Width	Item Number
30"	TWBSHELF-3030
36"	TWBSHELF-3630
42"	TWBSHELF-4230
48"	TWBSHELF-4830
54"	TWBSHELF-5430
60"	TWBSHELF-6030
66"	TWBSHELF-6630
72"	TWBSHELF-7230

We can provide one service per post:

Plumbing: up to 3 lines

Electric: up to 3 GFI's

DATA: 2 or 4 data ports

Table Frame

Table Frames (TF) are available in standard depths of 30" and 36". They can be fixed or adjustable in height. Many sizes are available. As standard, this 1000 lb. capacity table has strut installed for future suspended cabinet installation.

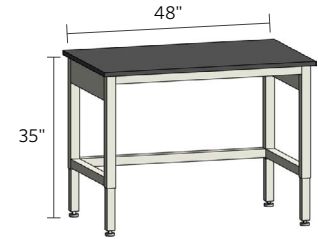

Table Frame Width Depth

Example: TF-AL4230-N

N = No top, frame only
 E = with epoxy top
 P = with phenolic top
 O = Other

L = Leveler Feet
 C = Locking Casters
 H = 600# Leveling Casters
 X = 1000# Leveling Casters

A = Adjustable Height
 S = Stationary (Fixed Height)

TABLE FRAME



Width	Item Number
30"	TF-AL3030-E
36"	TF-AL3630-E
42"	TF-AL4230-E
48"	TF-AL4830-E
54"	TF-AL5430-E
60"	TF-AL6030-E
66"	TF-AL6630-E
72"	TF-AL7230-E

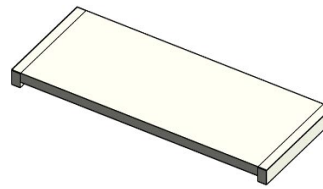

Width	Item Number
30"	TFSHELF-3030
36"	TFSHELF-3630
42"	TFSHELF-4230
48"	TFSHELF-4830
54"	TFSHELF-5430
60"	TFSHELF-6030
66"	TFSHELF-6630
72"	TFSHELF-7230

Table Frame End View

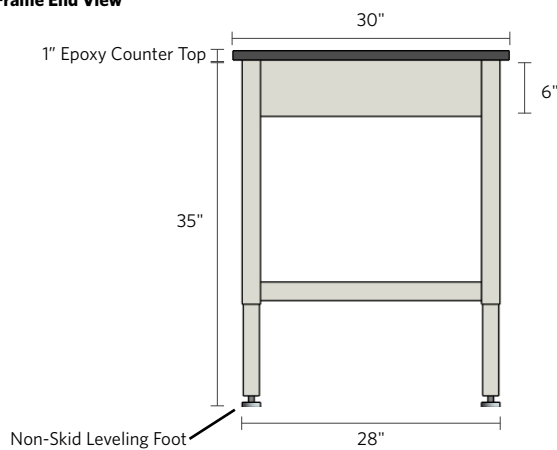
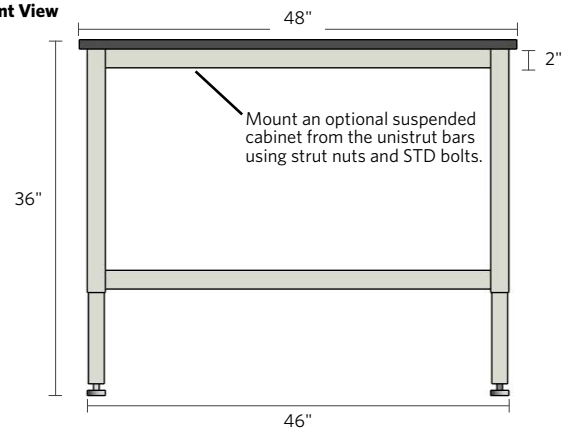

Table Frame Front View



Titan Systems Accessories

TITAN CORE RACEWAY

Adjustable Raceways can be used with the Titan Cores, Mobile Carts, or Work Benches. The brackets are included and the cord exits out of the bottom left, bottom right, top left, and top right.

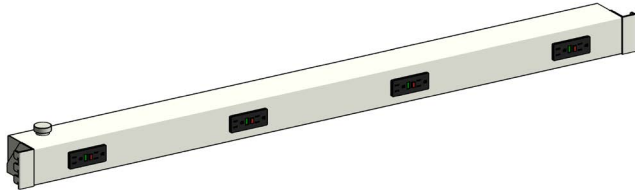

Width	Item Number
24"	TC-24RW-2G
30"	TC-30RW-3G
36"	TC-36RW-3G
42"	TC-42RW-4G
48"	TC-48RW-4G
54"	TC-54RW-5G
60"	TC-60RW-5G
66"	TC-66RW-6G
72"	TC-72RW-6G

Titan Core Raceway D = Duplex
G = GFI

Example: TC-36RW-6G

Width Quantity
(Note: Quantities are variable based on space available)

TITAN HANGING RAIL KIT

Hanging rail kits can be used with the Titan Cores, Mobile Carts, or Work Benches. The rails are required when wall cabinets are to be suspended from cores or benches. Equal or smaller width cabinets can be hang from brackets.

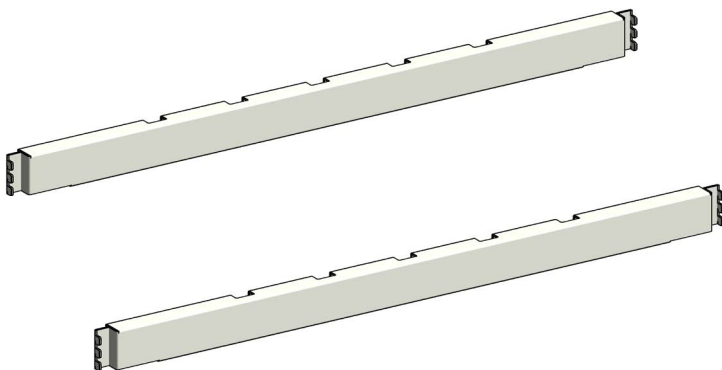

Width	Item Number
30"	THRK-30
36"	THRK-36
42"	THRK-42
48"	THRK-48
54"	THRK-54
60"	THRK-60
66"	THRK-66
72"	THRK-72

Under Shelf Task Lights

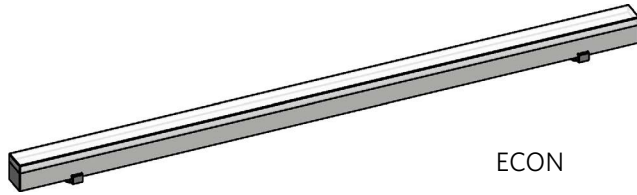

Width	Item Number
24"	LED ECON 24IN 4000K
36"	LED ECON 36IN 4000K

DAISY CHAIN CORD

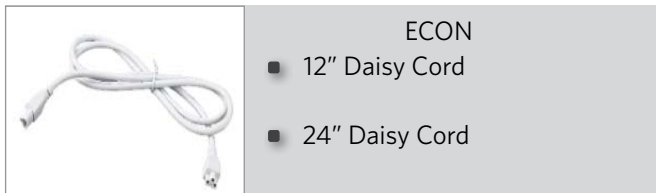

- ECON
- 12" Daisy Cord
 - 24" Daisy Cord

ECON KIT 1

- (1) 24" LED Econ Light
- (1) 24" Power Cord
- (2) Magnetic Clips
- (1) Power J-Box

POWER CORD

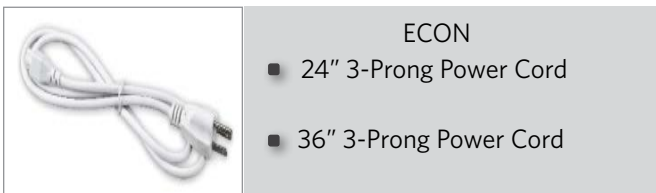

- ECON
- 24" 3-Prong Power Cord
 - 36" 3-Prong Power Cord

ECON KIT 2

- (2) 24" LED Econ Lights
- (1) 24" Power Cord
- (1) 12" Daisy Chain Cord
- (4) Magnetic Clips
- (1) Power J-Box

MAGNETIC MOUNTING CLIPS

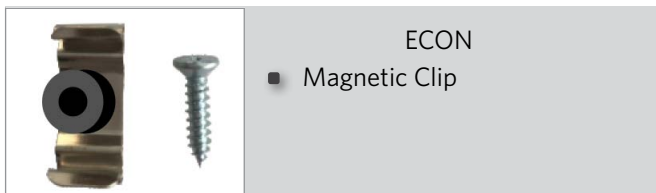

- ECON
- Magnetic Clip

ECON KIT 3

- (1) 36" LED Econ Light
- (1) 24" Power Cord
- (2) Magnetic Clips
- (1) Power J-Box

SWITCH JUNCTION BOX

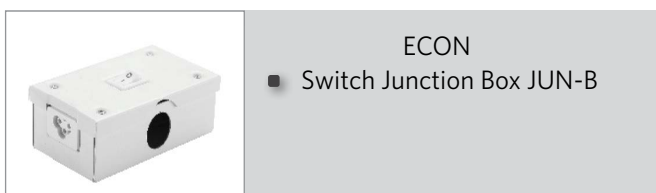

- ECON
- Switch Junction Box JUN-B

ECON KIT 4

- (2) 36" LED Econ Lights
- (1) 24" Power Cord
- (1) 12" Daisy Chain Cord
- (4) Magnetic Clips
- (1) Power J-Box

Under Shelf Task Lights

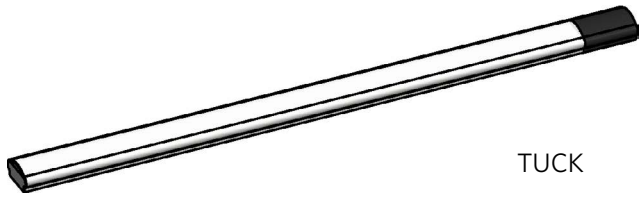

Width	Item Number
17"	LED TUCK 17IN 3500K
31"	LED TUCK 31IN 3500K

DAISY CHAIN CORD



TUCK KIT 1

- (1) 17" LED Tuck Light
- (1) 132" Power Cord
- (2) Magnetic Clips

POWER CORD

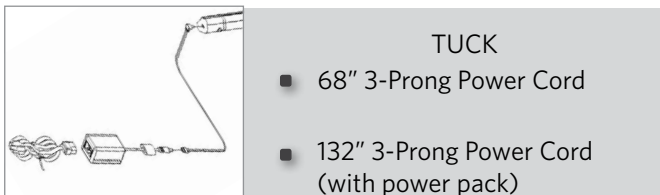

TUCK KIT 2

- (2) 17" LED Tu Lights
- (1) 132" Power Cord
- (1) 18" Daisy Chain Cord
- (4) Magnetic Clips

MAGNETIC MOUNTING CLIPS

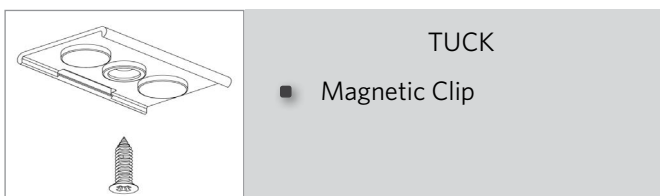

TUCK KIT 3

- (1) 31" LED Tuck Light
- (1) 132" Power Cord
- (2) Magnetic Clips

TUCK KIT 4

- (2) 31" LED Tu Lights
- (1) 132" Power Cord
- (1) 18" Daisy Chain Cord
- (4) Magnetic Clips



Air Master Systems Corp.

6480 Norton Center Drive, Muskegon, MI 49441 • 231.798.1111 • 231.798.4000 fax • airmastersystems.com