

Gemini System

60.0", 72.0", 84.0", and 96" width units

SPECIFICATION WORKSHEET - SINGLE OR DOUBLE-SIDED, TWIN-TUBE SUPPORT FRAME

RACEWAY ELECTRIC
Reference page 3 for selection sheet

SLOT 1 SLOT 2 SLOT 3 SLOT 4

ELECTRICAL OUTLET COLOR
[]
If other, specify: _____

BENCH FRAME COLOR
[]
If other, specify: _____

SERVICES (Right Post)
pre-plumbed to top of upright
see below for options

[] indicate service required

[] indicate service required

[] indicate service required

MODESTY PANEL
(non-adjustable) height at 36"

Yes

No

SINGLE / DOUBLE SIDED

[]

DATA PORTS (Left Post)
RJ45 (shielded)

[]

LOWER ELECTRIC (Left Post)
pre-wired as selected below

[]

WIDTH OF UNIT

[]

TABLE DEPTH

[]

Swap Sides, Plumbing on Left, Data on Right on GS1

POWER

ELECTRICAL WIRING OPTIONS

[]

Specified length (top of bench to ceiling) _____

ELECTRICAL PIGTAIL EXIT LOCATION

[]

GS1- Single-Sided:

[]

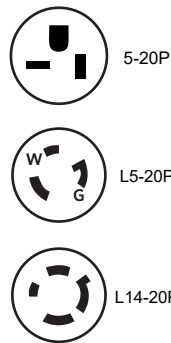

DATA

DATA EXIT LOCATION

[]

Specified length (top of bench to ceiling) _____

PLUMBING

SEE PLUMBING ILLUSTRATION ON SECOND PAGE FOR HOSE TYPES, CONNECTIONS, and FIXTURES. PLEASE SPECIFY IF BURNING GAS, OXYGEN, OR CLEAN GAS REQUIRED

-Your notes:

GS _ - _ - _ P _ D _ E

example: **GS2-4830-3P2D7E**

Width Depth 3 Plumbing Services

← 7 Electrical (Including lower)

Single-Sided = 1 / Double-Sided = 2 2 Data Ports



GEMINI BENCH

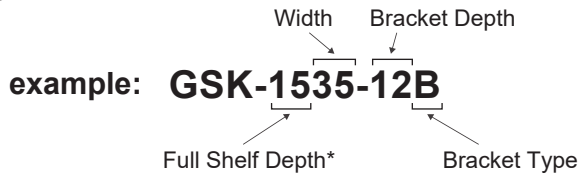

*This includes the 1" OR 3" extensions added to back edge.

Bracket Types:

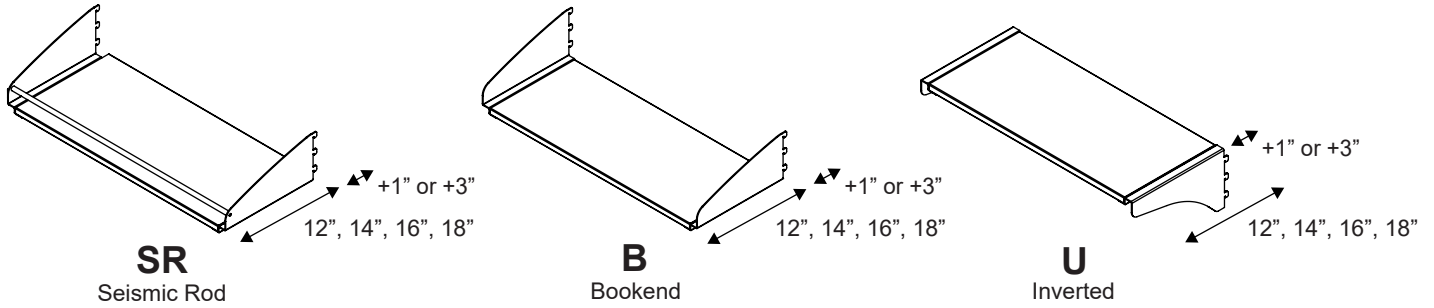

Gemini Width	Does it allow split shelving?	Part Numbers Needed
60"	Single & Double	GSK-__58-__ OR (2) GSK-__29-__
72"	Single & Double	GSK-__70-__ OR (2) GSK-__35-__
84"	Double Only	(2) GSK-__41-__
96"	Double Only	(2) GSK-__47-__

Bracket Selection:

Bracket ONLY:

ONLY Brackets*
No shelves

*For purchases with alternative shelving.

Depth*: *Depth w/o extensions

Shelf Depth Extension:

Quantity:

Width:

Comments:

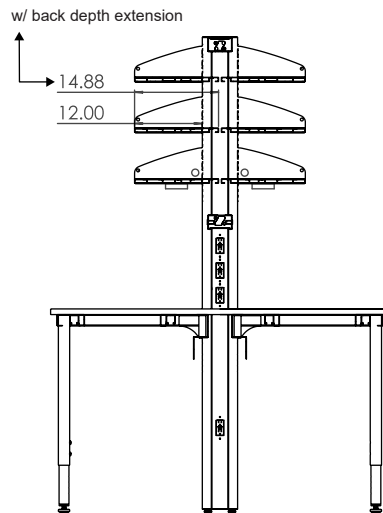
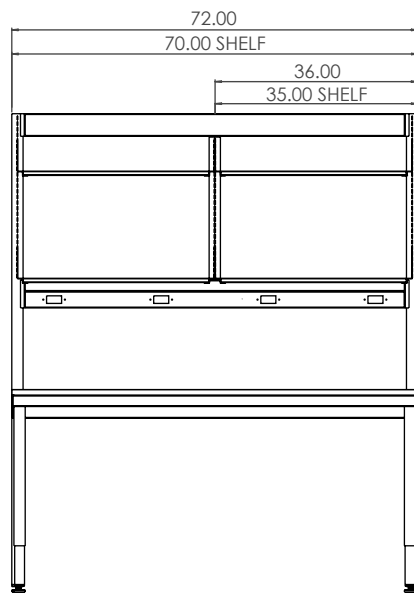

Gemini System

60.0", 72.0", 84.0", and 96" width units

SPECIFICATION WORKSHEET - PLUMBING

Specified length (top of bench to ceiling) _____

(Sold Separately)

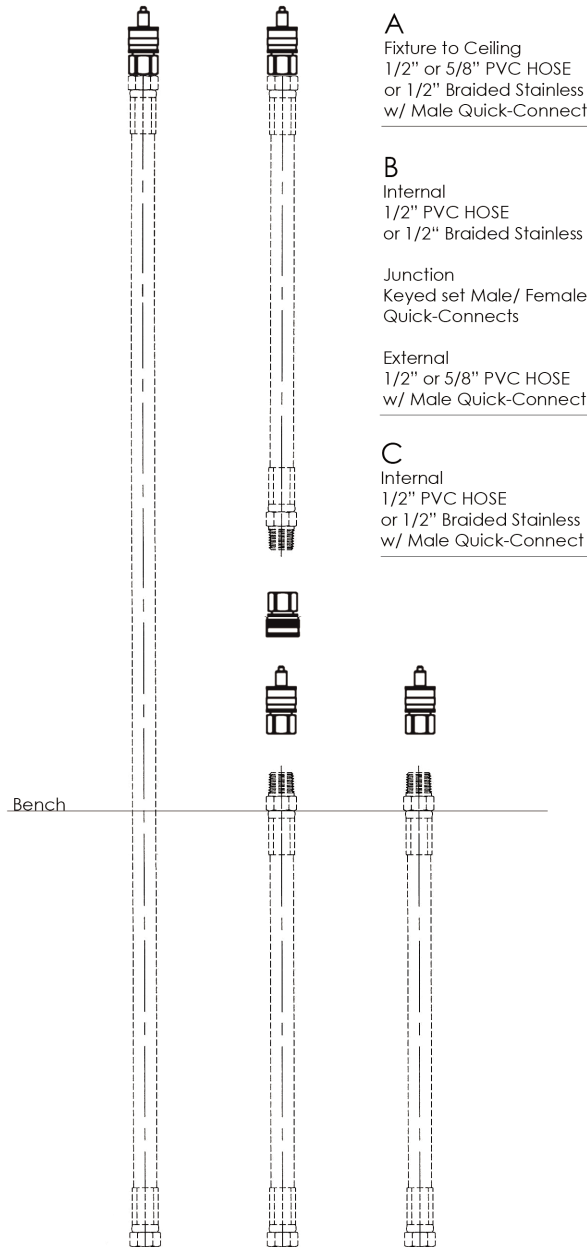
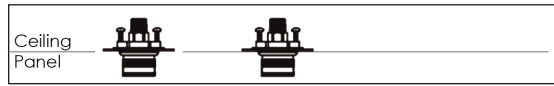

A
 Fixture to Ceiling
 1/2" or 5/8" PVC HOSE
 or 1/2" Braided Stainless
 w/ Male Quick-Connect

B
 Internal
 1/2" PVC HOSE
 or 1/2" Braided Stainless

Junction
 Keyed set Male/ Female
 Quick-Connects

External
 1/2" or 5/8" PVC HOSE
 w/ Male Quick-Connect

C
 Internal
 1/2" PVC HOSE
 or 1/2" Braided Stainless
 w/ Male Quick-Connect

PVC HOSE
 STAINLESS HOSE

A B C

(There is a maximum of three fixtures per side)

*4 Plumbing services maximum through Broen. Please contact AMS for Broen product information.

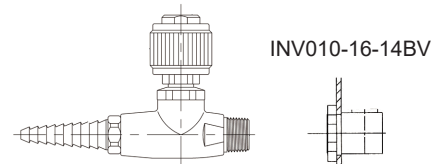

Single, Needle Valve - Black Knob

FINISH: _____

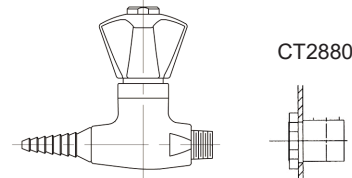

Single, Needle Valve - ColorTech Knob

FINISH: _____

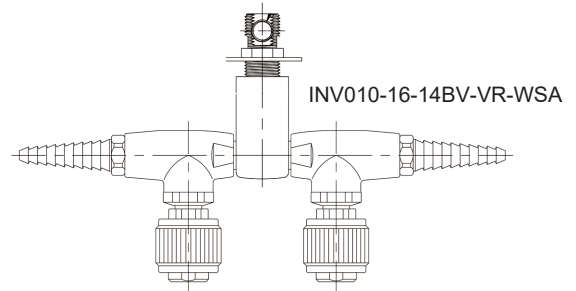

Double, Needle Valve - Black Knobs

FINISH: _____

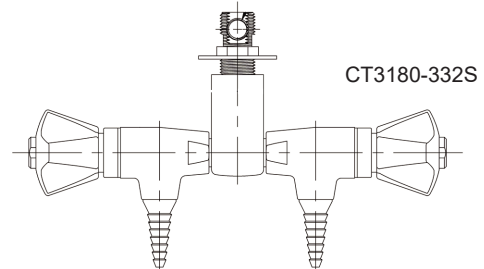

Double, Needle Valve - ColorTech Knobs

FINISH: _____

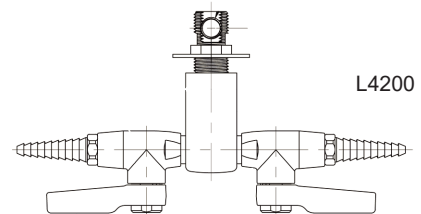

Double, Ball Valve - Lever Handles

FINISH: _____

Gemini System

60.0", 72.0", 84.0", and 96" width units

SPECIFICATION WORKSHEET - RACEWAY ELECTRICAL



- Black
- Brown
- Gray
- Ivory
- Light Almond
- White

120VAC, 20Amp GFI Duplex



- Black
- Gray
- Ivory
- Light Almond
- White

USB Charging Outlet



- Black
- Brown
- Gray
- Ivory
- Red
- Light Almond
- White

20Amp GFI / USB x2 Combo



RJ45 Shielded Coupler

Gemini Systems **60.0"**, **72.0"**, and **84.0"** Width Units allow **up to 5** GFI slots on the top raceway.
 Double-sided allow **up to 10** GFI slots on the top raceway.

60.0", 72.0" and 84.0" ONLY

From Left to Right facing front of bench

SLOT 1	SLOT 2	SLOT 3	SLOT 4	SLOT 5
<input type="text"/>	<input type="text"/>	<input type="text"/>	<input type="text"/>	<input type="text"/>

Slots 6 - 10 (Use only if Double-Sided)

SLOT 6	SLOT 7	SLOT 8	SLOT 9	SLOT 10
<input type="text"/>	<input type="text"/>	<input type="text"/>	<input type="text"/>	<input type="text"/>

Gemini Systems **96.0"** Width Unit allow **up to 6** GFI slots on the top raceway.
 Double-sided allow **up to 12** GFI slots on the top raceway.

96.0" ONLY

From Left to Right facing front of bench

SLOT 1	SLOT 2	SLOT 3	SLOT 4	SLOT 5
<input type="text"/>	<input type="text"/>	<input type="text"/>	<input type="text"/>	<input type="text"/>

SLOT 6

Slots 7 - 12 (Use only if Double-Sided)

SLOT 7	SLOT 8	SLOT 9	SLOT 10	SLOT 11
<input type="text"/>	<input type="text"/>	<input type="text"/>	<input type="text"/>	<input type="text"/>

SLOT 12