

Metal Laboratory Casework

product catalog





Since 1975, Air Master Systems has manufactured chemical fume hoods, filtration hoods, and laboratory furniture for the R&D, institutional, industrial, government and biotech markets.



Contents

Cabinet Specifications	4
Ordering Guide	5
Options Menu	6
Base Cabinets — Standing Height	9
Open Cabinets	9
Door Cabinets	9
Drawer Cabinets	10
Door & Drawer Cabinets	13
Shelves & Pull Out Shelves	17
Corner Cabinets	17
Three or Five Equal Drawer Cabinet	18
Sink & Fume Hood Cabinets	19
Base Cabinets — Sitting Height	20
Open Cabinets	20
Door Cabinets	20
Drawer Cabinets	21
Door & Drawer Cabinets	24
Sink & Fume Hood Cabinets	26
Corner Cabinets	27
Base Cabinets — ADA Height	28
Open Cabinets	28
Door Cabinets	28
Drawer Cabinets	29
Door & Drawer Cabinets	30
Corner Cabinets	31
Sink & Fume Hood Cabinets	32
Base Cabinets — Corrosives & Flammables	34
Corrosives Storage Cabinets	34
Flammables Storage Cabinets	37
Vacuum Pump Cabinets	39
Mobile Cabinets	41
Suspended Cabinets	43
Overlay Cabinets	45
Tall Cabinets	47
Wall Cabinets — 24" Height	49
Wall Cabinets — 30" Height	51
Wall Cabinets — 36" Height	53
Wall Cabinets — 48" Height	55
Aprons	57
Utility Tables	58
Filler Panels	59
Knee Space Rails and Panels	61
Counter Island Reagent	63
Accessories	64
Cylinder Racks	65
Umbilicals	66

Note:

Images in this catalog are for representation only. For complete product specifications, contact your AMS representative.

Cabinet Specifications

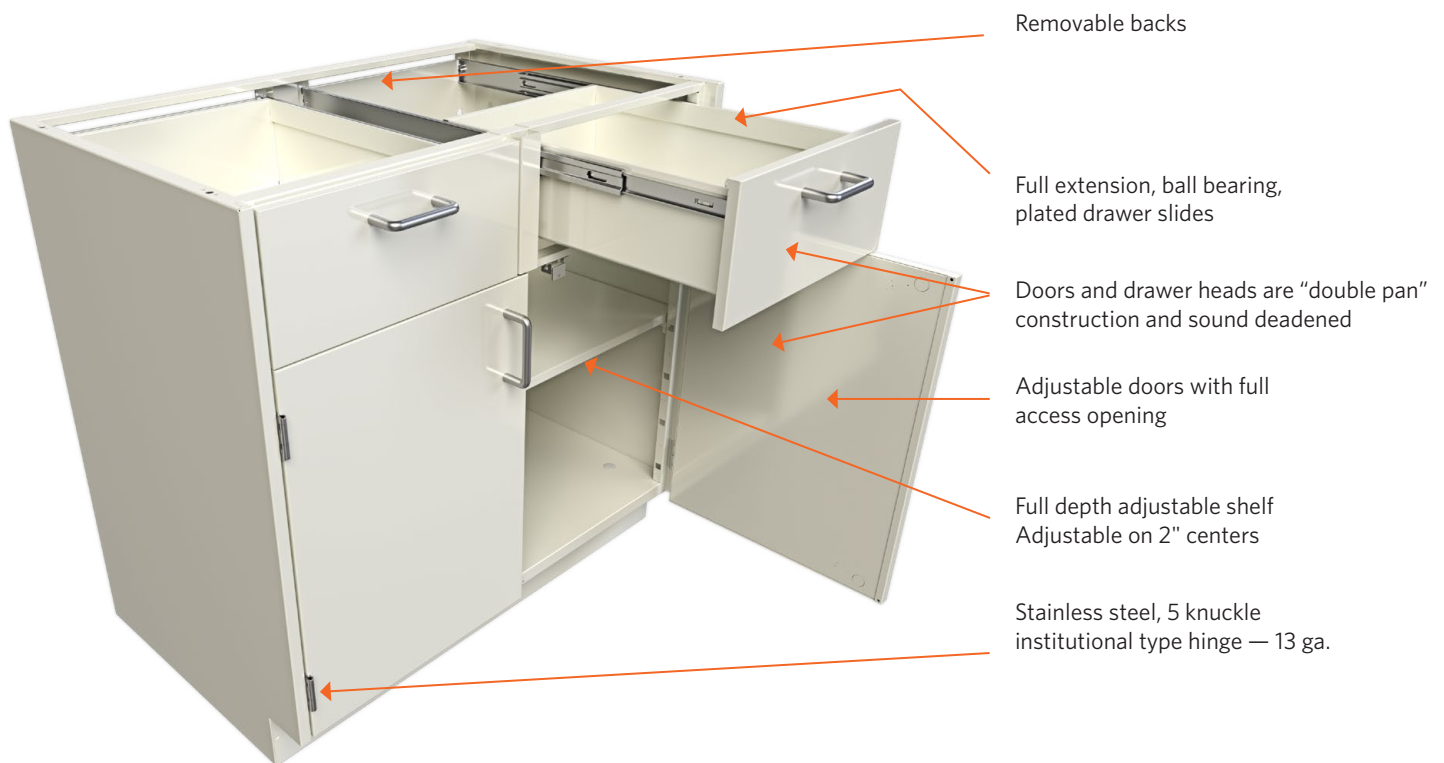

All surfaces shall be painted or zinc plated. The paint is chemical and UV resistant baked on epoxy-hybrid powder. Specific test data is available upon request.

Gauges of casework components

Aprons	18 ga.
Back Panels	18 ga.
Bottom Panels	18 ga.
Drawer/Door Outer Panel	20 ga.
Door Inner Panel	20 ga.
Drawer Bodies	20 ga.
Legs - 2" sq. tube	16 ga.
Shelves	18 ga.
Side Panels	18 ga.
Table Frames	18 ga.
Security Panels	20 ga.

For complete specifications, request our full line of product specifications. Subject to change.

IMPORTANT NOTE:

All part numbers may not reflect actual dimensions.

Ordering Guide

S	TYPE	HEIGHT	WIDTH	STYLE	OPTIONS
Cabinet Type					
B	Base (Inset)				
F	Floor (Tall)				
HB	Suspended Base				
OB	Overlay Base				
MB	Mobile Base				
W	Wall				
ASB	Acid Storage Base				
FSB	Flammable Storage				
Base Cabinet Height					
29"	Sitting Height				
32"	ADA Height				
35"	Standing Height				
Wall Cabinet Height					
24"	30"	36"	48"		
Cabinet Width					
12"	15"	18"	21"	24"	30"
36"	42"	48"			
Cabinet Style					
Reference AMS catalog for door and drawer configurations					
Option Suffix (for base cabinet)					
-19	Depth (NSP)		-PS	1 Pull Out Shelf (NSP)	
-LK	Locks		-2PS	2 Pull Out Shelves (NSP)	
-LTK	Toe Kick LH Side Of Cabinet (NSP)		-3PS	3 Pull Out Shelves (NSP)	
-RTK	Toe Kick RH Side Of Cabinet (NSP)		-VK	Vent Kit (only for acid cabinet)	
-SS	Stainless Steel, Type 304		-VD	Vertical Divider (NSP)	
-SS316	Stainless Steel, Type 316 (NSP)		-FB	Finished Backs	
-BB	Bread Board (NSP)		-EC	End Covers	
			-F	Flush Pull	
Option Suffix (for wall cabinet)					
-16	16" Depth		-TG	Tempered Glass	
-LK	Locks		-LG	Laminate (Safety) Glass	
-SS	Stainless Steel, Type 304		-F	Flush Pull	
-SS316	Stainless Steel, Type 316 (NSP)				
Option Suffix (for mobile cabinet)					
-19	Depth (NSP)		-T	3/4" THK. Metal Top	
-LK	Locks		-E	3/4" THK. Epoxy Top	
-SS	Stainless Steel, Type 304		-P	3/4" THK. Phenolic Top	
-SS316	Stainless Steel, Type 316 (NSP)		-2"	Casters (in lieu of standard 3")	
-BB	Bread Board (NSP)		-F	Flush Pull	
Option Suffix (for tall cabinet)					
-LK	Locks		-LG	Laminate (Safety) Glass	
-SS	Stainless Steel, Type 304		-W	Wardrobe Bracket	
-SS316	Stainless Steel, Type 316 (NSP)		-PS	1 Pull Out Shelves (NSP)	
-TG	Tempered Glass		-F	Flush Pull	

*NSP=Non-Standard Product

Options Menu

DOOR & DRAWER FRONTS



Inset Steel
(Standard Default)



Flush Overlay
Steel

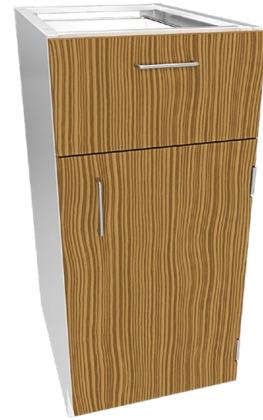

Flush Overlay
Wood

DRAWER SLIDES

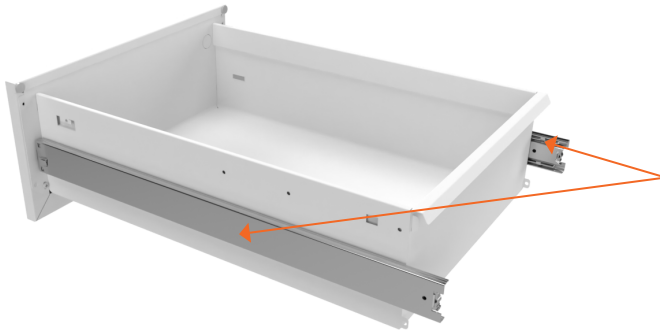

- 100 lb. Full Extension (Standard Default)
- 100 lb. Full Extension Soft Close
- 200 lb. Full Extension
- 200 lb. Full Extension Soft Close

CASTERS



- 3" Casters (Standard Default)
- 2" Casters

HINGES



Inset Steel
Stainless Steel 5-Knuckle



Flush Overlay
Stainless Steel 5-Knuckle

Options Menu

MAGNETIC & ROLLER CATCH



Magnetic Catch
(Standard Default)



Roller Catch

LOCKS

Master 5-Pin
(Standard Default)



PULLS



- Rectangular Brushed Aluminum
(Aluminum Rectangular Bar)



- Aluminum Wire Pulls



- Stainless Steel Wire Pulls



- Recessed Aluminum



- Painted Recessed Aluminum
(AMS standard colors available)

Options Menu

LABEL HOLDERS



- None (Standard Default)
- One each door and drawer
- One per pair of doors and each drawer

BASE UNIT SHELF



- One piece adjustable (Standard Default)
Extra Quantity Available

GLASS FRAMED DOORS



- 3/16" Clear Float Glass (Standard Default)
- 1/4" Laminated Safety Glass
- 1/4" Tempered Safety Glass

SECURITY PANELS



- Without Security Panel (Standard Default)
- With Security Panel

GLASS DOORS



- 1/4" Clear Float Glass (Standard Default)
- Laminated Glass
- Tempered Glass

Base Cabinets — Standing Height

Standing height base cabinets are 34.75" high and 23.00" deep. Units are available in various widths as shown. Door units feature a single shelf as standard. All open units have 2 shelves. Additional shelves are available. Specify left- or right-hinged doors using the suffix "L" or "R". If locks are required use the suffix "LK". If a finished back is required use the suffix "FB".

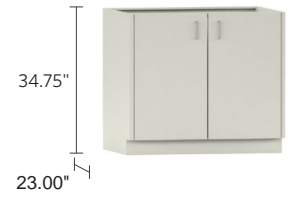

OPEN CABINETS



Up to 24" wide

Width	Item Number
12"	SB3512-000
15"	SB3515-000
18"	SB3518-000
21"	SB3521-000
24"	SB3524-000



30" and wider

Width	Item Number
30"	SB3530-000
36"	SB3536-000
42"	SB3542-000
48"	SB3548-000

DOOR CABINETS



Example: SB3515-100R

Width	Left & Right Hinged
12"	SB3512-100L
15"	SB3515-100L
18"	SB3518-100L
21"	SB3521-100L
24"	SB3524-100L
12"	SB3512-100R
15"	SB3515-100R
18"	SB3518-100R
21"	SB3521-100R
24"	SB3524-100R

Note: L(left) or R(right) refers to door hinge side.



30" and wider

Width	Item Number
30"	SB3530-200
36"	SB3536-200
42"	SB3542-200
48"	SB3548-200



Example: SB3530-100-LHDRPN

Width	Left & Right Hinged
30"	SB3530-100-LHDRPN
36"	SB3536-100-LHDRPN
42"	SB3542-100-LHDRPN
48"	SB3548-100-LHDRPN
30"	SB3530-100-RHDRPN
36"	SB3536-100-RHDRPN
42"	SB3542-100-RHDRPN
48"	SB3548-100-RHDRPN

Note: LHD(left) or RHD(right) refers to door hinge side. RPN refers to right panel next to door or LPN refers to left panel next to door.



Example: SB3530-100-RHDRPN

Base Cabinets — Standing Height

Standing height base cabinets are 34.75" high and 23.00" deep. Units are available in various widths as shown. Drawer units feature 100 lb. full extension slides as standard. If locks are required use the suffix "LK". If a finished back is required use the suffix "FB".

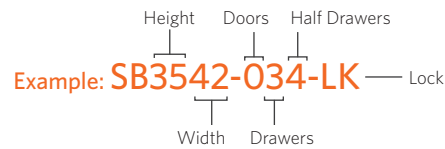
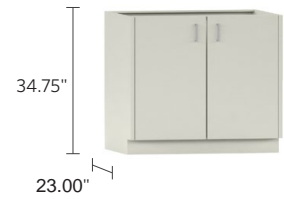

DRAWER CABINETS



Up to 24" wide

Width	Item Number
12"	SB3512-032
15"	SB3515-032
18"	SB3518-032
21"	SB3521-032
24"	SB3524-032



30" and wider

Width	Item Number
30"	SB3530-032
36"	SB3536-032
42"	SB3542-032
48"	SB3548-032



Up to 24" wide

Width	Item Number
12"	SB3512-024
15"	SB3515-024
18"	SB3518-024
21"	SB3521-024
24"	SB3524-024



30" and wider

Width	Item Number
30"	SB3530-028
36"	SB3536-028
42"	SB3542-028
48"	SB3548-028



Up to 24" wide

Width	Item Number
12"	SB3512-008
15"	SB3515-008
18"	SB3518-008
21"	SB3521-008
24"	SB3524-008



30" and wider

Width	Item Number
30"	SB3530-008
36"	SB3536-008
42"	SB3542-008
48"	SB3548-008



Up to 24" wide

Width	Item Number
12"	SB3512-040
15"	SB3515-040
18"	SB3518-040
21"	SB3521-040
24"	SB3524-040



30" and wider

Width	Item Number
30"	SB3530-040
36"	SB3536-040
42"	SB3542-040
48"	SB3548-040

Base Cabinets — Standing Height

Standing height base cabinets are 34.75" high and 23.00" deep. Units are available in various widths as shown. Drawer units feature 100 lb. full extension slides as standard. If locks are required use the suffix "LK". If a finished back is required use the suffix "FB".

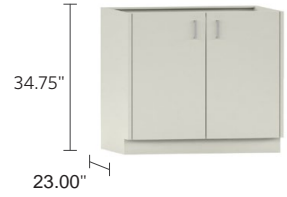

DRAWER CABINETS



Up to 24" wide

Width	Item Number
12"	SB3512-012-1F*
15"	SB3515-012-1F*
18"	SB3518-012-1F
21"	SB3521-012-1F
24"	SB3524-012-1F



30" and wider

Width	Item Number
30"	SB3530-024-2F*
36"	SB3536-024-2F
42"	SB3542-024-2F
48"	SB3548-024-2F



Up to 24" wide

Width	Item Number
12"	SB3512-000-2F*
15"	SB3515-000-2F*
18"	SB3518-000-2F
21"	SB3521-000-2F
24"	SB3524-000-2F



30" and wider

Width	Item Number
30"	SB3530-000-4F*
36"	SB3536-000-4F
42"	SB3542-000-4F
48"	SB3548-000-4F



Up to 24" wide

Width	Item Number
12"	SB3512-004-1F*
15"	SB3515-004-1F*
18"	SB3518-004-1F
21"	SB3521-004-1F
24"	SB3524-004-1F



30" and wider

Width	Item Number
30"	SB3530-008-2F*
36"	SB3536-008-2F
42"	SB3542-008-2F
48"	SB3548-008-2F



Up to 24" wide

Width	Item Number
12"	SB3512-020-1F*
15"	SB3515-020-1F*
18"	SB3518-020-1F
21"	SB3521-020-1F
24"	SB3524-020-1F



30" and wider

Width	Item Number
30"	SB3530-040-2F*
36"	SB3536-040-2F
42"	SB3542-040-2F
48"	SB3548-040-2F

* No file rails provided on these sizes

Base Cabinets — Standing Height

Standing height base cabinets are 34.75" high and 23.00" deep. Units are available in various widths as shown. Drawer units feature 100 lb. full extension slides as standard. If locks are required use the suffix "LK". If a finished back is required use the suffix "FB".

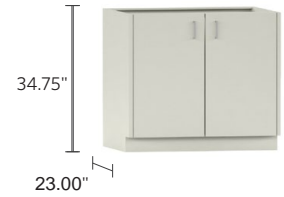

Example: SB3542-034-LK — Lock

Labels: Height (34.75"), Doors (034), Half Drawers (034), Lock (LK), Width (34), Drawers (034)

DRAWER CABINETS



30" and wider

Width	Item Number
30"	SB3530-050
36"	SB3536-050
42"	SB3542-050
48"	SB3548-050



30" and wider

Width	Item Number
30"	SB3530-064
36"	SB3536-064
42"	SB3542-064
48"	SB3548-064



30" and wider

Width	Item Number
30"	SB3530-060
36"	SB3536-060
42"	SB3542-060
48"	SB3548-060



30" and wider

Width	Item Number
30"	SB3530-070
36"	SB3536-070
42"	SB3542-070
48"	SB3548-070



30" and wider

Width	Item Number
30"	SB3530-080
36"	SB3536-080
42"	SB3542-080
48"	SB3548-080



30" and wider

Width	Item Number
30"	SB3530-052
36"	SB3536-052
42"	SB3542-052
48"	SB3548-052



30" and wider

Width	Item Number
30"	SB3530-044
36"	SB3536-044
42"	SB3542-044
48"	SB3548-044



30" and wider

Width	Item Number
30"	SB3530-034
36"	SB3536-034
42"	SB3542-034
48"	SB3548-034

Base Cabinets — Standing Height

Standing height base cabinets are 34.75" high and 23.00" deep. Units are available in various widths as shown. Drawer units feature 100 lb. full extension slides as standard. Door units feature a single shelf as standard. Additional shelves are available. Specify left- or right-hinged doors using the suffix "L" or "R". If locks are required use the suffix "LK". If a finished back is required use the suffix "FB".

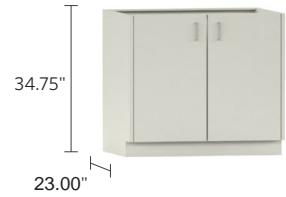

Example: **SB3542-00(16)-LK** — Lock
 Height: 34.75"
 Doors: 00 (0 drawers)
 Half Drawers: 16 (16 drawers)
 Width: 42"
 Drawers: 16

Example: **SB3542-110R-LK** — Lock
 Height: 34.75"
 Doors: 110 (1 door)
 Half Drawers: 00 (0 drawers)
 Width: 42"
 Drawers: 00
 Right Hinged: R

DRAWER CABINETS



Up to 24" wide

Width	Item Number
12"	SB3512-016
15"	SB3515-016
18"	SB3518-016
21"	SB3521-016
24"	SB3524-016



30" and wider

Width	Item Number
30"	SB3530-016
36"	SB3536-016
42"	SB3542-016
48"	SB3548-016



30" and wider

Width	Item Number
30"	SB3530-00(16)
36"	SB3536-00(16)
42"	SB3542-00(16)
48"	SB3548-00(16)

DOOR & DRAWER CABINETS



Right-hinged door shown

Width	Left & Right Hinged
12"	SB3512-110L
15"	SB3515-110L
18"	SB3518-110L
21"	SB3521-110L
24"	SB3524-110L
12"	SB3512-110R
15"	SB3515-110R
18"	SB3518-110R
21"	SB3521-110R
24"	SB3524-110R



Right-hinged door shown

Width	Left & Right Hinged
12"	SB3512-102L
15"	SB3515-102L
18"	SB3518-102L
21"	SB3521-102L
24"	SB3524-102L
12"	SB3512-102R
15"	SB3515-102R
18"	SB3518-102R
21"	SB3521-102R
24"	SB3524-102R

Base Cabinets — Standing Height

Standing height base cabinets are 34.75" high and 23.00" deep. Units are available in various widths as shown. Drawer units feature 100 lb. full extension slides as standard. Door units feature a single shelf as standard. Additional shelves are available. Specify left- or right-hinged doors using the suffix "L" or "R". If locks are required use the suffix "LK". If a finished back is required use the suffix "FB".

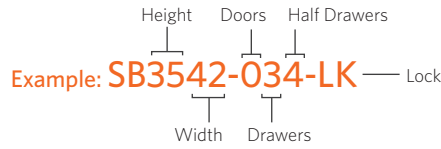
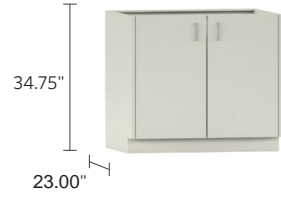

DOOR & DRAWER CABINETS



30" and wider

Width	Item Number
30"	SB3530-212
36"	SB3536-212
42"	SB3542-212
48"	SB3548-212



30" and wider

Width	Item Number
30"	SB3530-220
36"	SB3536-220
42"	SB3542-220
48"	SB3548-220



30" and wider

Width	Item Number
30"	SB3530-202-A
36"	SB3536-202-A
42"	SB3542-202-A
48"	SB3548-202-A



Right-hinged door shown

Width	Left & Right Hinged
30"	SB3530-202L
36"	SB3536-202L
42"	SB3542-202L
48"	SB3548-202L
30"	SB3530-202R
36"	SB3536-202R
42"	SB3542-202R
48"	SB3548-202R



30" and wider

Width	Item Number
30"	SB3530-204
36"	SB3536-204
42"	SB3542-204
48"	SB3548-204



Right-hinged door shown

Width	Left & Right Hinged
30"	SB3530-142L
36"	SB3536-142L
42"	SB3542-142L
48"	SB3548-142L
30"	SB3530-142R
36"	SB3536-142R
42"	SB3542-142R
48"	SB3548-142R



Right-hinged door shown

Width	Left & Right Hinged
30"	SB3530-118L
36"	SB3536-118L
42"	SB3542-118L
48"	SB3548-118L
30"	SB3530-118R
36"	SB3536-118R
42"	SB3542-118R
48"	SB3548-118R



Right-hinged door shown

Width	Left & Right Hinged
30"	SB3530-118-AL
36"	SB3536-118-AL
42"	SB3542-118-AL
48"	SB3548-118-AL
30"	SB3530-118-AR
36"	SB3536-118-AR
42"	SB3542-118-AR
48"	SB3548-118-AR

Base Cabinets — Standing Height

Standing height base cabinets are 34.75" high and 23.00" deep. Units are available in various widths as shown. Drawer units feature 100 lb. full extension slides as standard. Door units feature a single shelf as standard. Additional shelves are available. Specify left- or right-hinged doors using the suffix "L" or "R". If locks are required use the suffix "LK". If a finished back is required use the suffix "FB".

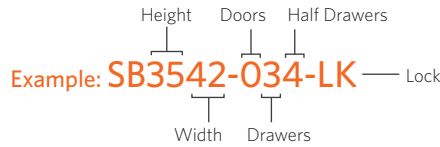
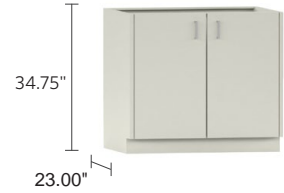

DOOR & DRAWER CABINETS



Right-hinged door shown

Width	Left & Right Hinged
30"	SB3530-140L
36"	SB3536-140L
42"	SB3542-140L
48"	SB3548-140L
30"	SB3530-140R
36"	SB3536-140R
42"	SB3542-140R
48"	SB3548-140R



Right-hinged door shown

Width	Left & Right Hinged
30"	SB3530-140-BL
36"	SB3536-140-BL
42"	SB3542-140-BL
48"	SB3548-140-BL
30"	SB3530-140-BR
36"	SB3536-140-BR
42"	SB3542-140-BR
48"	SB3548-140-BR



Right-hinged door shown

Width	Left & Right Hinged
30"	SB3530-134L
36"	SB3536-134L
42"	SB3542-134L
48"	SB3548-134L
30"	SB3530-134R
36"	SB3536-134R
42"	SB3542-134R
48"	SB3548-134R



Right-hinged door shown

Width	Left & Right Hinged
30"	SB3530-134-AL
36"	SB3536-134-AL
42"	SB3542-134-AL
48"	SB3548-134-AL
30"	SB3530-134-AR
36"	SB3536-134-AR
42"	SB3542-134-AR
48"	SB3548-134-AR



30" and wider

Width	Item Number
30"	SB3530-210
36"	SB3536-210
42"	SB3542-210
48"	SB3548-210



Right-hinged door shown

Width	Left & Right Hinged
30"	SB3530-210-AL
36"	SB3536-210-AL
42"	SB3542-210-AL
48"	SB3548-210-AL
30"	SB3530-210-AR
36"	SB3536-210-AR
42"	SB3542-210-AR
48"	SB3548-210-AR

Base Cabinets — Standing Height

Standing height base cabinets are 34.75" high and 23.00" deep. Units are available in various widths as shown. Drawer units feature 100 lb. full extension slides as standard. Door units feature a single shelf as standard. Additional shelves are available. Specify left- or right-hinged doors using the suffix "L" or "R". If locks are required use the suffix "LK". If a vertical divider is required between cup board and drawer section use the suffix "VD". If a finished back is required use the suffix "FB".

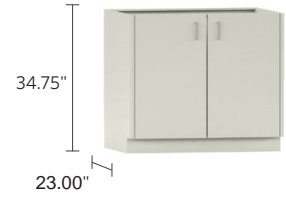

DOOR & DRAWER CABINETS



Right-hinged door shown

Width	Left & Right Hinged
30"	SB3530-150L
36"	SB3536-150L
42"	SB3542-150L
48"	SB3548-150L
30"	SB3530-150R
36"	SB3536-150R
42"	SB3542-150R
48"	SB3548-150R



Right-hinged door shown

Width	Left & Right Hinged
30"	SB3530-116L
36"	SB3536-116L
42"	SB3542-116L
48"	SB3548-116L
30"	SB3530-116R
36"	SB3536-116R
42"	SB3542-116R
48"	SB3548-116R



Right-hinged door shown

Width	Left & Right Hinged
30"	SB3530-126L
36"	SB3536-126L
42"	SB3542-126L
48"	SB3548-126L
30"	SB3530-126R
36"	SB3536-126R
42"	SB3542-126R
48"	SB3548-126R



Right-hinged door shown

Width	Left & Right Hinged
30"	SB3530-126-AL
36"	SB3536-126-AL
42"	SB3542-126-AL
48"	SB3548-126-AL
30"	SB3530-126-AR
36"	SB3536-126-AR
42"	SB3542-126-AR
48"	SB3548-126-AR



Right-hinged door shown

Width	Left & Right Hinged
30"	SB3530-108L
36"	SB3536-108L
42"	SB3542-108L
48"	SB3548-108L
30"	SB3530-108R
36"	SB3536-108R
42"	SB3542-108R
48"	SB3548-108R



Right-hinged door shown

Width	Left & Right Hinged
30"	SB3530-132L
36"	SB3536-132L
42"	SB3542-132L
48"	SB3548-132L
30"	SB3530-132R
36"	SB3536-132R
42"	SB3542-132R
48"	SB3548-132R

Base Cabinets — Standing Height

Standing height base cabinets are 34.75" high and 23.00" deep. Units are available in various widths as shown. Drawer units feature 100 lb. full extension slides as standard. Door units feature a single shelf as standard. Additional shelves are available. Specify left- or right-hinged doors using the suffix "L" or "R". If locks are required use the suffix "LK". If a finished back is required use the suffix "FB".

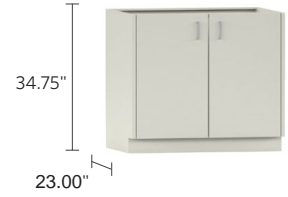

SHELVES & PULL OUT SHELVES

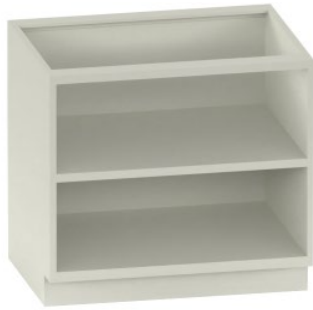

Width	Item Number	Actual Width
12"	SBS1222	11 3/4"
15"	SBS1522	14 3/4"
18"	SBS1822	17 3/4"
21"	SBS2122	20 3/4"
24"	SBS2422	23 3/4"
30"	SBS3022	29 3/4"
36"	SBS3622	35 3/4"
42"	SBS4222	41 3/4"
48"	SBS4822	47 3/4"

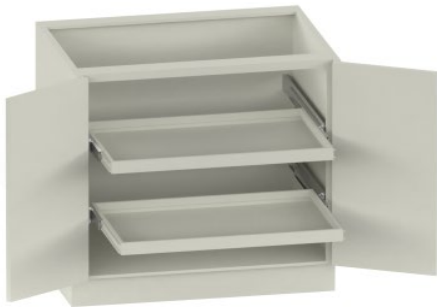

Width	Item Number	Actual Width
15"	SBPOS-1522	11 7/8"
18"	SBPOS-1822	14 7/8"
21"	SBPOS-2122	17 7/8"
24"	SBPOS-2422	20 7/8"
30"	SBPOS-3022	26 7/8"
36"	SBPOS-3622	32 7/8"
42"	SBPOS-4222	38 7/8"
48"	SBPOS-4822	44 7/8"

CORNER CABINETS



Right-hinged door shown

Left Hinged	Right Hinged
SC3514-100L	SC3514-100R

Lazy Susan Add-On Suffix
"LS"



Right-hinged door shown

Left Hinged	Right Hinged
SC3514-100-SL	SC3514-100-SR

Left Hinged with Louvers	Right Hinged with Louvers
SC3514-100-SVL	SC3514-100-SVR

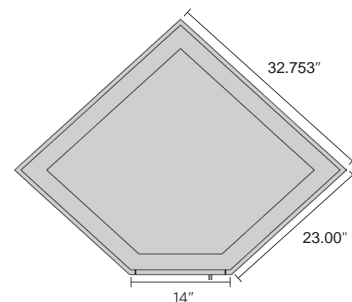

Base Cabinets — Standing Height

Standing height base cabinets are 34.75" high and 23.00" deep. Units are available in various widths as shown. Drawer units feature 100 lb. full extension slides as standard. Door units feature a single shelf as standard. Additional shelves are available. Specify left- or right-hinged doors using the suffix "L" or "R". If locks are required use the suffix "LK". If a finished back is required use the suffix "FB".

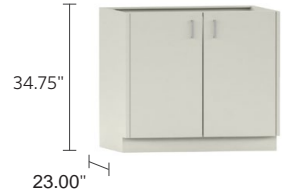

THREE OR FIVE EQUAL DRAWER CABINETS



Width	Item Number
12"	SB3512-03X
15"	SB3515-03X
18"	SB3518-03X
21"	SB3521-03X
24"	SB3524-03X

Up to 24" wide



30" and wider

Width	Item Number
30"	SB3530-03X
36"	SB3536-03X
42"	SB3542-03X
48"	SB3548-03X



Width	Item Number
12"	SB3512-05X
15"	SB3515-05X
18"	SB3518-05X
21"	SB3521-05X
24"	SB3524-05X

Up to 24" wide



30" and wider

Width	Item Number
30"	SB3530-05X
36"	SB3536-05X
42"	SB3542-05X
48"	SB3548-05X



30" and wider

Width	Item Number
30"	SB3530-0(10)X
36"	SB3536-0(10)X
42"	SB3542-0(10)X
48"	SB3548-0(10)X



Right-hinged door shown

Width	Left & Right Hinged
30"	SB3530-15X-L
36"	SB3536-15X-L
42"	SB3542-15X-L
48"	SB3548-15X-L
30"	SB3530-15X-R
36"	SB3536-15X-R
42"	SB3542-15X-R
48"	SB3548-15X-R

Base Cabinets — Standing Height

Standing height base cabinets are 34.75" high and 23.00" deep. Units are available in various widths as shown. Drawer units feature 100 lb. full extension slides as standard. Specify left- or right-hinged doors using the suffix "L" or "R". If locks are required use the suffix "LK". If a finished back is required use the suffix "FB".

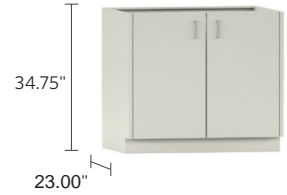

SINK & FUME HOOD CABINETS



Right-hinged door shown.
 Change to "-SV(R/L)" for
 Vents instead of just "S(R/L)"

Width	Left & Right Hinged
12"	SB3512-100-SL
15"	SB3515-100-SL
18"	SB3518-100-SL
21"	SB3521-100-SL
24"	SB3524-100-SL
12"	SB3512-100-SR
15"	SB3515-100-SR
18"	SB3518-100-SR
21"	SB3521-100-SR
24"	SB3524-100-SR



30" and wider

Width	Item Number
30"	SB3530-200-S
36"	SB3536-200-S
42"	SB3542-200-S
48"	SB3548-200-S

Change to "-SV" for Vents
 instead of just "S"



Right-hinged door shown
 -FHD "Full Height Doors"

Width	Left & Right Hinged
12"	SB3512-100-SL-FHD
15"	SB3515-100-SL-FHD
18"	SB3518-100-SL-FHD
21"	SB3521-100-SL-FHD
24"	SB3524-100-SL-FHD
12"	SB3512-100-SR-FHD
15"	SB3515-100-SR-FHD
18"	SB3518-100-SR-FHD
21"	SB3521-100-SR-FHD
24"	SB3524-100-SR-FHD

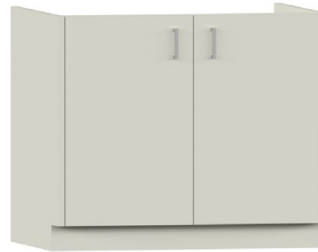

30" and wider

Width	Item Number
30"	SB3530-200-S-FHD
36"	SB3536-200-S-FHD
42"	SB3542-200-S-FHD
48"	SB3548-200-S-FHD

-FHD "Full Height Doors"

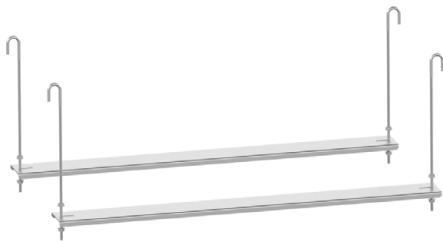

Sink Support Assembly

Item Number
SSS-C14
SSS-18
SSS-24
SSS-30
SSS-36
SSS-42
SSS-48
SSS-52
SSS-58



Width	Item Number
52"	SB3552-200-S
58"	SB3558-200-S

Available with vents:
 Change to "-SV" for Vents
 instead of just "S"



Width	Item Number
52"	SB3552-200-SI
58"	SB3558-200-SI

Base Cabinets — Sitting Height

Sitting height cabinets are 28.75" high and 23.00" deep. Units are available in various widths as shown. Door units feature single shelf as standard. Additional shelves are available. Specify left- or right-hinged doors using the suffix "L" or "R". If locks are required, use the suffix "LK". If a finished back is required use the suffix "FB".

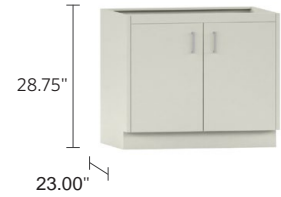

OPEN CABINETS



Up to 24" wide

Width	Item Number
12"	SB2912-000
15"	SB2915-000
18"	SB2918-000
21"	SB2921-000
24"	SB2924-000

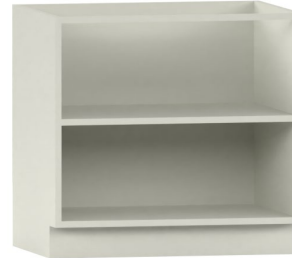

30" and wider

Width	Item Number
30"	SB2930-000
36"	SB2936-000
42"	SB2942-000
48"	SB2948-000

DOOR CABINETS



Right-hinged door shown

Width	Left & Right Hinged
12"	SB2912-100L
15"	SB2915-100L
18"	SB2918-100L
21"	SB2921-100L
24"	SB2924-100L
12"	SB2912-100R
15"	SB2915-100R
18"	SB2918-100R
21"	SB2921-100R
24"	SB2924-100R



30" and wider

Width	Item Number
30"	SB2930-200
36"	SB2936-200
42"	SB2942-200
48"	SB2948-200



Example: SB2930-100-RHDRPN



Example: SB2930-100-LHDRPN

Width	Left & Right Hinged
30"	SB2930-100-LHDRPN
36"	SB2936-100-LHDRPN
42"	SB2942-100-LHDRPN
48"	SB2948-100-LHDRPN
30"	SB2930-100-RHDRPN
36"	SB2936-100-RHDRPN
42"	SB2942-100-RHDRPN
48"	SB2948-100-RHDRPN

Note: LHD(left) or RHD(right) refers to door hinge side. RPN refers to right panel next to door or LPN refers to left panel next to door.

Base Cabinets — Sitting Height

Sitting height cabinets are 28.75" high and 23.00" deep. Units are available in various widths as shown. Drawer units feature 100 lb. full extension slides as standard. If locks are required, use the suffix "LK". If a finished back is required use the suffix "FB".



Example: **SB2930-022-LK**

Labels: Height (28.75"), Width (23.00"), Doors (2), Half Drawers (2), Drawers (2), Lock (LK)

DRAWER CABINETS



Width	Item Number
12"	SB2912-030
15"	SB2915-030
18"	SB2918-030
21"	SB2921-030
24"	SB2924-030

Up to 24" wide



Width	Item Number
30"	SB2930-030
36"	SB2936-030
42"	SB2942-030
48"	SB2948-030

30" and wider



Width	Item Number
12"	SB2912-022
15"	SB2915-022
18"	SB2918-022
21"	SB2921-022
24"	SB2924-022

Up to 24" wide



Width	Item Number
30"	SB2930-022
36"	SB2936-022
42"	SB2942-022
48"	SB2948-022

30" and wider



Width	Item Number
12"	SB2912-014
15"	SB2915-014
18"	SB2918-014
21"	SB2921-014
24"	SB2924-014

Up to 24" wide



Width	Item Number
30"	SB2930-014
36"	SB2936-014
42"	SB2942-014
48"	SB2948-014

30" and wider

Base Cabinets — Sitting Height

Sitting height cabinets are 28.75" high and 23.00" deep. Units are available in various widths as shown. Drawer units feature 100 lb. full extension slides as standard. If locks are required, use the suffix "LK". If a finished back is required use the suffix "FB".



DRAWER CABINETS



Up to 24" wide

Width	Item Number
12"	SB2912-006
15"	SB2915-006
18"	SB2918-006
21"	SB2921-006
24"	SB2924-006



30" and wider

Width	Item Number
30"	SB2930-006
36"	SB2936-006
42"	SB2942-006
48"	SB2948-006



Up to 24" wide

Width	Item Number
12"	SB2912-002-1F*
15"	SB2915-002-1F*
18"	SB2918-002-1F
21"	SB2921-002-1F
24"	SB2924-002-1F



30" and wider

Width	Item Number
30"	SB2930-004-2F*
36"	SB2936-004-2F
42"	SB2942-004-2F
48"	SB2948-004-2F



Up to 24" wide

Width	Item Number
15"	SB2915-000-2F**
18"	SB2918-000-2F**
21"	SB2921-000-2F**
24"	SB2924-000-2F**



30" and wider

Width	Item Number
30"	SB2930-000-4F**
36"	SB2936-000-4F**
42"	SB2942-000-4F**
48"	SB2948-000-4F**



Up to 24" wide

Width	Item Number
15"	SB2915-010-1F*
18"	SB2918-010-1F
21"	SB2921-010-1F
24"	SB2924-010-1F



30" and wider

Width	Item Number
30"	SB2930-020-2F*
36"	SB2936-020-2F
42"	SB2942-020-2F
48"	SB2948-020-2F

* No file rails provided on these sizes

** Box Drawer no rails provided

Base Cabinets — Sitting Height

Sitting height cabinets are 28.75" high and 23.00" deep. Units are available in various widths as shown. Drawer units feature 100 lb. full extension slides as standard. If locks are required, use the suffix "LK". If a finished back is required use the suffix "FB".



DRAWER CABINETS



30" and wider

Width	Item Number
30"	SB2930-060
36"	SB2936-060
42"	SB2942-060
48"	SB2948-060



30" and wider

Width	Item Number
30"	SB2930-044
36"	SB2936-044
42"	SB2942-044
48"	SB2948-044



30" and wider

Width	Item Number
30"	SB2930-040
36"	SB2936-040
42"	SB2942-040
48"	SB2948-040



30" and wider

Width	Item Number
30"	SB2930-028
36"	SB2936-028
42"	SB2942-028
48"	SB2948-028

Base Cabinets — Sitting Height

Sitting height cabinets are 28.75" high and 23.00" deep. Units are available in various widths as shown. No shelves are available in sitting height base cabinets with the combination of doors and drawers. Drawer units feature 100 lb. full extension slides as standard. Specify left or right-hinged doors using the suffix "L" or "R". If locks are required, use the suffix "LK". If a finished back is required use the suffix "FB".



Example: **SB2930-110R-LK** — Lock

Labels: Height, Doors, Half Drawers, Width, Drawers, Right Hinged

DOOR & DRAWER CABINETS



Right-hinged door shown

Width	Left & Right Hinged
12"	SB2912-110L
15"	SB2915-110L
18"	SB2918-110L
21"	SB2921-110L
24"	SB2924-110L
12"	SB2912-110R
15"	SB2915-110R
18"	SB2918-110R
21"	SB2921-110R
24"	SB2924-110R



Right-hinged door shown

Width	Left & Right Hinged
12"	SB2912-102L
15"	SB2915-102L
18"	SB2918-102L
21"	SB2921-102L
24"	SB2924-102L
12"	SB2912-102R
15"	SB2915-102R
18"	SB2918-102R
21"	SB2921-102R
24"	SB2924-102R



30" and wider

Width	Item Number
30"	SB2930-220
36"	SB2936-220
42"	SB2942-220
48"	SB2948-220



30" and wider

Width	Item Number
30"	SB2930-212
36"	SB2936-212
42"	SB2942-212
48"	SB2948-212



30" and wider

Width	Item Number
30"	SB2930-204
36"	SB2936-204
42"	SB2942-204
48"	SB2948-204



Right-hinged door shown

Width	Left & Right Hinged
30"	SB2930-132L
36"	SB2936-132L
42"	SB2942-132L
48"	SB2948-132L
30"	SB2930-132R
36"	SB2936-132R
42"	SB2942-132R
48"	SB2948-132R

Base Cabinets — Sitting Height

Sitting height cabinets are 28.75" high and 23.00" deep. Units are available in various widths as shown. No shelves are available in sitting height base cabinets with the combination of doors and drawers. Drawer units feature 100 lb. full extension slides as standard. Door units feature single shelf as standard. Additional shelves are available. Specify left- or right-hinged doors using the suffix "L" or "R". If locks are required, use the suffix "LK". If a finished back is required use the suffix "FB".



DOOR & DRAWER CABINETS



30" and wider

Width	Item Number
30"	SB2930-210
36"	SB2936-210
42"	SB2942-210
48"	SB2948-210



Right-hinged door shown

Width	Left & Right Hinged
30"	SB2930-210-AL
36"	SB2936-210-AL
42"	SB2942-210-AL
48"	SB2948-210-AL
30"	SB2930-210-AR
36"	SB2936-210-AR
42"	SB2942-210-AR
48"	SB2948-210-AR



30" and wider

Width	Item Number
30"	SB2930-202-A
36"	SB2936-202-A
42"	SB2942-202-A
48"	SB2948-202-A



Right-hinged door shown

Width	Left & Right Hinged
30"	SB2930-202L
36"	SB2936-202L
42"	SB2942-202L
48"	SB2948-202L
30"	SB2930-202R
36"	SB2936-202R
42"	SB2942-202R
48"	SB2948-202R



Right-hinged door shown

Width	Left & Right Hinged
30"	SB2930-130L
36"	SB2936-130L
42"	SB2942-130L
48"	SB2948-130L
30"	SB2930-130R
36"	SB2936-130R
42"	SB2942-130R
48"	SB2948-130R



Right-hinged door shown

Width	Left & Right Hinged
30"	SB2930-130-AL
36"	SB2936-130-AL
42"	SB2942-130-AL
48"	SB2948-130-AL
30"	SB2930-130-AR
36"	SB2936-130-AR
42"	SB2942-130-AR
48"	SB2948-130-AR

Base Cabinets — Sitting Height

Sitting height cabinets are 28.75" high and 23.00" deep. Units are available in various widths as shown. No shelves are available in sitting height base cabinets with the combination of doors and drawers. Drawer units feature 100 lb. full extension slides as standard. Door units feature single shelf as standard. Additional shelves are available. Specify left- or right-hinged doors using the suffix "L" or "R". If locks are required, use the suffix "LK". If a vertical divider is required between cup board and drawer section use the suffix "VD". If a finished back is required use the suffix "FB".



DOOR & DRAWER CABINETS



Right-hinged door shown

Width	Left & Right Hinged
30"	SB2930-116L
36"	SB2936-116L
42"	SB2942-116L
48"	SB2948-116L
30"	SB2930-116R
36"	SB2936-116R
42"	SB2942-116R
48"	SB2948-116R



Right-hinged door shown

Width	Left & Right Hinged
30"	SB2930-116-AL
36"	SB2936-116-AL
42"	SB2942-116-AL
48"	SB2948-116-AL
30"	SB2930-116-AR
36"	SB2936-116-AR
42"	SB2942-116-AR
48"	SB2948-116-AR



Right-hinged door shown

Width	Left & Right Hinged
30"	SB2930-124L
36"	SB2936-124L
42"	SB2942-124L
48"	SB2948-124L
30"	SB2930-124R
36"	SB2936-124R
42"	SB2942-124R
48"	SB2948-124R



Right-hinged door shown

Width	Left & Right Hinged
30"	SB2930-124-AL
36"	SB2936-124-AL
42"	SB2942-124-AL
48"	SB2948-124-AL
30"	SB2930-124-AR
36"	SB2936-124-AR
42"	SB2942-124-AR
48"	SB2948-124-AR



Right-hinged door shown

Width	Left & Right Hinged
30"	SB2930-114L
36"	SB2936-114L
42"	SB2942-114L
48"	SB2948-114L
30"	SB2930-114R
36"	SB2936-114R
42"	SB2942-114R
48"	SB2948-114R



Right-hinged door shown

Width	Left & Right Hinged
30"	SB2930-108L
36"	SB2936-108L
42"	SB2942-108L
48"	SB2948-108L
30"	SB2930-108R
36"	SB2936-108R
42"	SB2942-108R
48"	SB2948-108R

SINK & FUME HOOD CABINETS



Width	Left Hinged	Right Hinged
12"	SB2912-100-SL	SB2912-100-SR
15"	SB2915-100-SL	SB2915-100-SR
18"	SB2918-100-SL	SB2918-100-SR
21"	SB2921-100-SL	SB2921-100-SR
24"	SB2924-100-SL	SB2924-100-SR



Width	Left Hinged	Right Hinged
12"	SB2912-100-SL-FHD	SB2912-100-SR-FHD
15"	SB2915-100-SL-FHD	SB2915-100-SR-FHD
18"	SB2918-100-SL-FHD	SB2918-100-SR-FHD
21"	SB2921-100-SL-FHD	SB2921-100-SR-FHD
24"	SB2924-100-SL-FHD	SB2924-100-SR-FHD

-FHD "Full Height Doors"

Base Cabinets — Sitting Height

Sitting height cabinets are 28.75" high and 23.00" deep. Units are available in various widths as shown. Drawer units feature 100 lb. full extension slides as standard. Full height door units feature single shelf as standard. Additional shelves are available. Specify left- or right-hinged doors using the suffix "L" or "R". If locks are required, use the suffix "LK". If a finished back is required use the suffix "FB".



SINK & FUME HOOD CABINETS



Width	Item Number
30"	SB2930-200-S
36"	SB2936-200-S
42"	SB2942-200-S
48"	SB2948-200-S

Available with vents:
Change to "-SV" for Vents
instead of just "S"



Width	Item Number
30"	SB2930-200-S-FHD
36"	SB2936-200-S-FHD
42"	SB2942-200-S-FHD
48"	SB2948-200-S-FHD

-FHD "Full Height Doors"

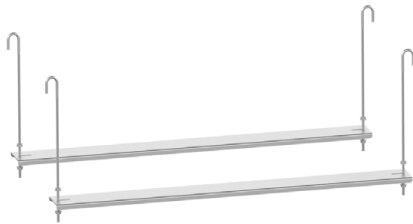

Sink Support Assembly

Item Number
SSS-C14
SSS-18
SSS-24
SSS-30
SSS-36
SSS-42
SSS-48
SSS-52
SSS-58



Width	Item Number
52"	SB2952-200-S
58"	SB2958-200-S



Width	Item Number
52"	SB2952-200-SI
58"	SB2958-200-SI

CORNER CABINETS



Right-hinged door shown

Item Number
Left & Right Hinged
SC2914-100L
SC2914-100R

Lazy Susan Add-On Suffix
"LS"



Right-hinged door shown

Left Hinged	Right Hinged
SC2914-100-SL	SC2914-100-SR

Left Hinged with Louvers	Right Hinged with Louvers
SC2914-100-SVL	SC2914-100-SVR

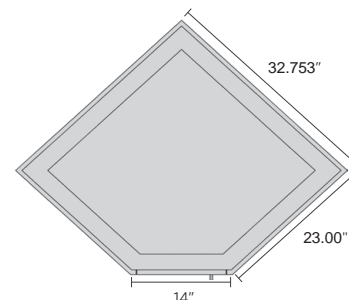

Base Cabinets — ADA Height

ADA height cabinets are 31.75" high and 23.00" deep. Units are available in various widths as shown. Door units feature single shelf as standard. Additional shelves are available. Specify left- or right-hinged doors using the suffix "L" or "R". If locks are required, use the suffix "LK". If a finished back is required use the suffix "FB".



OPEN CABINETS



Up to 24" wide

Width	Item Number
12"	SB3212-000
15"	SB3215-000
18"	SB3218-000
21"	SB3221-000
24"	SB3224-000



30" and wider

Width	Item Number
30"	SB3230-000
36"	SB3236-000
42"	SB3242-000
48"	SB3248-000

DOOR CABINETS



Right-hinged door shown

Width	Left & Right Hinged
12"	SB3212-100L
15"	SB3215-100L
18"	SB3218-100L
21"	SB3221-100L
24"	SB3224-100L
12"	SB3212-100R
15"	SB3215-100R
18"	SB3218-100R
21"	SB3221-100R
24"	SB3224-100R



30" and wider

Width	Item Number
30"	SB3230-200
36"	SB3236-200
42"	SB3242-200
48"	SB3248-200

Base Cabinets — ADA Height

ADA height cabinets are 31.75" high and 23.00" deep. Units are available in various widths as shown. Full height door units feature single shelf as standard. Additional shelves are available. Drawer units feature 100 lb. full extension slides as standard. If locks are required, use the suffix "LK". If a finished back is required use the suffix "FB".



DRAWER CABINETS



Width	Item Number
12"	SB3212-031
15"	SB3215-031
18"	SB3218-031
21"	SB3221-031
24"	SB3224-031

12" and wider



Width	Item Number
30"	SB3230-031
36"	SB3236-031
42"	SB3242-031
48"	SB3248-031

30" and wider



Width	Item Number
12"	SB3212-020-1F**
15"	SB3215-020-1F**
18"	SB3218-020-1F**
21"	SB3221-020-1F**
24"	SB3224-020-1F**

Up to 24" wide



Width	Item Number
30"	SB3230-040-2F**
36"	SB3236-040-2F**
42"	SB3242-040-2F**
48"	SB3248-040-2F**

30" and wider



Width	Item Number
15"	SB3215-012-1F**
18"	SB3218-012-1F**
21"	SB3221-012-1F**
24"	SB3224-012-1F**

Up to 24" wide



Width	Item Number
30"	SB3230-024-2F**
36"	SB3236-024-2F**
42"	SB3242-024-2F**
48"	SB3248-024-2F**

30" and wider



Width	Item Number
30"	SB3230-062
36"	SB3236-062
42"	SB3242-062
48"	SB3248-062

30" and wider

**** Box Drawer no rails provided**

Base Cabinets — ADA Height

ADA height cabinets are 31.75" high and 23.00" deep. Units are available in various widths as shown. Drawer units feature 100 lb. full extension slides as standard. Full height door units feature single shelf as standard. Additional shelves are available. Specify left- or right-hinged doors using the suffix "L" or "R". If locks are required, use the suffix "LK". If a finished back is required use the suffix "FB".



DOOR & DRAWER CABINETS



Right-hinged door shown

Width	Left & Right Hinged
12"	SB3212-110L
15"	SB3215-110L
18"	SB3218-110L
21"	SB3221-110L
24"	SB3224-110L
12"	SB3212-110R
15"	SB3215-110R
18"	SB3218-110R
21"	SB3221-110R
24"	SB3224-110R



30" and wider

Width	Item Number
30"	SB3230-202-A
36"	SB3236-202-A
42"	SB3242-202-A
48"	SB3248-202-A



30" and wider

Width	Item Number
30"	SB3230-210
36"	SB3236-210
42"	SB3242-210
48"	SB3248-210



30" and wider

Width	Item Number
30"	SB3230-201
36"	SB3236-201
42"	SB3242-201
48"	SB3248-201



30" and wider

Width	Item Number
30"	SB3230-220
36"	SB3236-220
42"	SB3242-220
48"	SB3248-220



30" and wider

Width	Item Number
30"	SB3230-202
36"	SB3236-202
42"	SB3242-202
48"	SB3248-202

Base Cabinets — ADA Height

ADA height cabinets are 31.75" high and 23.00" deep. Units are available in various widths as shown. Drawer units feature 100 lb. full extension slides as standard. Door units feature single shelf as standard. Additional shelves are available. Specify left- or right-hinged doors using the suffix "L" or "R". If locks are required, use the suffix "LK". If a finished back is required use the suffix "FB".



CORNER CABINETS



Right-hinged door shown

Left Hinged	Right Hinged
SC3214-100L-LS	SC3214-100R-LS

Lazy Susan Add-On Suffix
"LS"

Left Hinged	Right Hinged
SC3214-100L	SC3214-100R



Right-hinged door shown

Left Hinged	Right Hinged
SC3214-100-SL	SC3214-100-SR

Left Hinged with Louvers	Right Hinged with Louvers
SC3214-100-SVL	SC3214-100-SVR

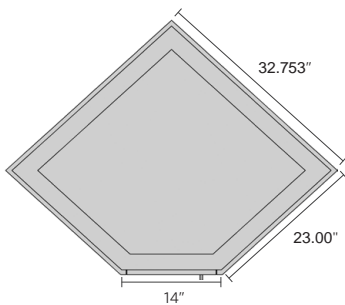

Base Cabinets — ADA Height

ADA height cabinets are 31.75" high and 23.00" deep. Units are available in various widths as shown. Full height door units feature single shelf as standard. Additional shelves are available. Specify left- or right-hinged doors using the suffix "L" or "R". If locks are required, use the suffix "LK". If a finished back is required use the suffix "FB".



SINK & FUME HOOD CABINETS



Width	Left & Right Hinged
12"	SB3212-100-SL
15"	SB3215-100-SL
18"	SB3218-100-SL
21"	SB3221-100-SL
24"	SB3224-100-SL
12"	SB3224-100-SR
15"	SB3224-100-SR
18"	SB3224-100-SR
21"	SB3221-100-SR
24"	SB3224-100-SR

Right-hinged door shown
Change to "-SV(R/L)" for
Vents instead of just "S(R/L)"



Width	Item Number
30"	SB3230-200-S
36"	SB3236-200-S
42"	SB3242-200-S
48"	SB3248-200-S

Available with vents:
Change to "-SV" for Vents
instead of just "S"



Width	Left & Right Hinged
12"	SB3212-100-SL-FHD
15"	SB3215-100-SL-FHD
18"	SB3218-100-SL-FHD
21"	SB3221-100-SL-FHD
24"	SB3224-100-SL-FHD
12"	SB3212-100-SR-FHD
15"	SB3215-100-SR-FHD
18"	SB3218-100-SR-FHD
21"	SB3221-100-SR-FHD
24"	SB3224-100-SR-FHD

-FHD "Full Height Doors"



Width	Item Number
30"	SB3230-200-S-FHD
36"	SB3236-200-S-FHD
42"	SB3242-200-S-FHD
48"	SB3248-200-S-FHD

-FHD "Full Height Doors"



Width	Item Number
52"	SB3252-200-S
58"	SB3258-200-S



Width	Item Number
52"	SB3252-200-SI
58"	SB3258-200-SI

Base Cabinets — ADA Height

ADA height cabinets are 31.75" high and 23.00" deep. Units are available in various widths as shown. Drawer units feature 100 lb. full extension slides as standard. Door units feature single shelf as standard. Additional shelves are available. Specify left- or right-hinged doors using the suffix "L" or "R". If locks are required, use the suffix "LK". If a finished back is required use the suffix "FB".



SINK & FUME HOOD CABINETS



Width	Item Number
36"	SADAKSC36
42"	SADAKSC42
48"	SADAKSC48

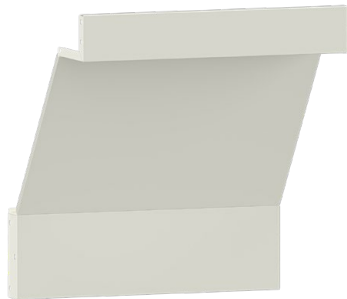

Width	Item Number
30"	SADAKSP30
36"	SADAKSP36
42"	SADAKSP42
48"	SADAKSP48

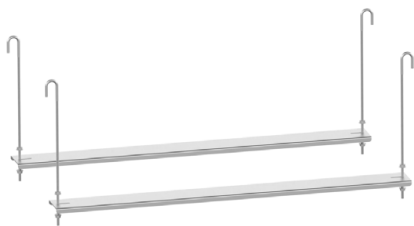

Sink Support Assembly

Item Number
SSS-C14
SSS-18
SSS-24
SSS-30
SSS-36
SSS-42
SSS-48
SSS-52
SSS-58

Base Cabinets — Corrosives, Bases, Oxidizers

Corrosives storage cabinets are reinforced steel with a hi-tech performance polymer alloy coating, which provides 100% coverage against corrosion. Cabinets are available in 18" and 22" depths.

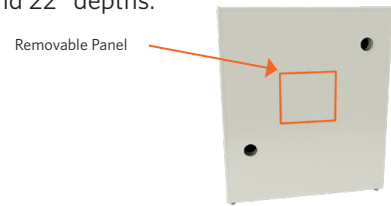
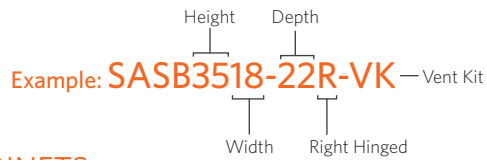

CORROSIVES STORAGE CABINETS



SASB3524-18



SASB3530-18

Width	Sitting Height	ADA Height	Standing Height
18"	SASB2918-18	SASB3218-18	SASB3518-18
24"	SASB2924-18	SASB3224-18	SASB3524-18
30"	SASB2930-18	SASB3230-18	SASB3530-18
36"	SASB2936-18	SASB3236-18	SASB3536-18
42"	SASB2942-18	SASB3242-18	SASB3542-18
48"	SASB2948-18	SASB3248-18	SASB3548-18

Width	Sitting Height	ADA Height	Standing Height
18"	SASB2918-22	SASB3218-22	SASB3518-22
24"	SASB2924-22	SASB3224-22	SASB3524-22
30"	SASB2930-22	SASB3230-22	SASB3530-22
36"	SASB2936-22	SASB3236-22	SASB3536-22
42"	SASB2942-22	SASB3242-22	SASB3542-22
48"	SASB2948-22	SASB3248-22	SASB3548-22

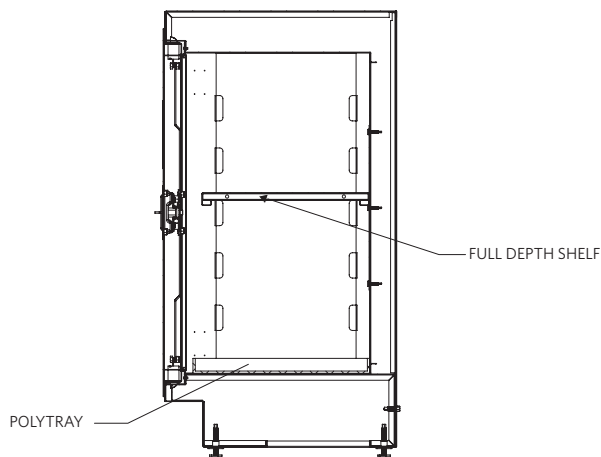

18-3/8" ACTUAL DEPTH

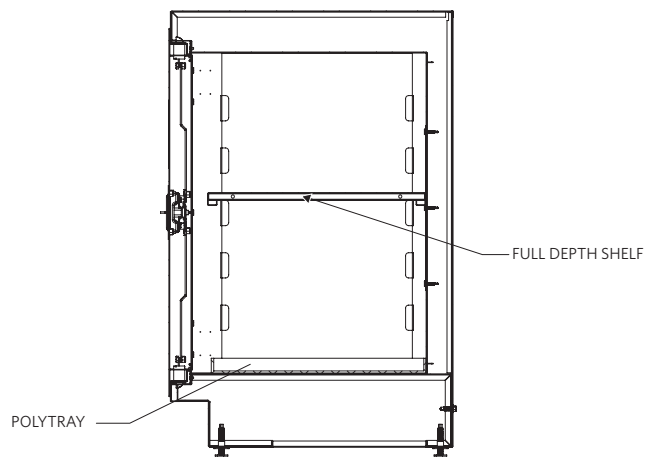

22-3/8" ACTUAL DEPTH

Base Cabinets — Corrosives, Acids, Bases

Corrosives storage cabinets are reinforced steel with a hi-tech performance polymer alloy coating, which provides 100% coverage against corrosion. Cabinets are available in 18" and 22" depths.

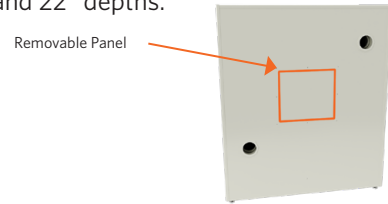
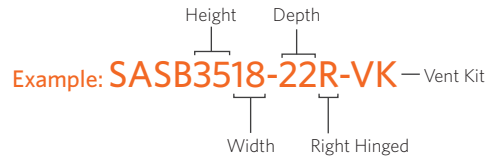

CORROSIVES STORAGE CABINETS

24" Wide (1 DOOR)

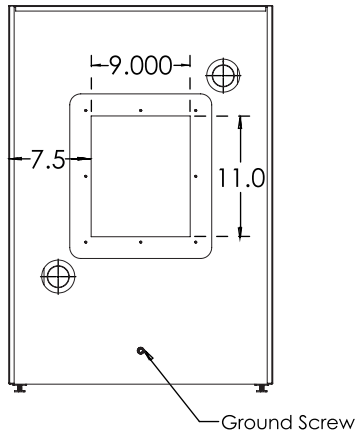

30" Wide (2 DOOR)

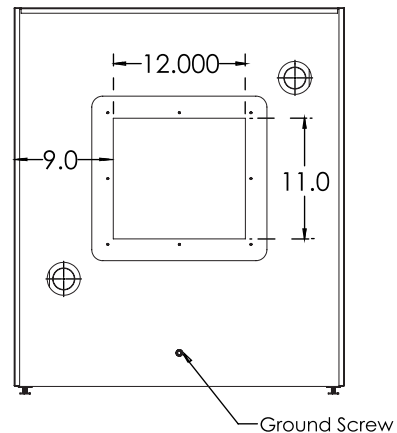

SASBM2930-22

Mobile cabinets are available. Please contact your AMS representative.

Width	Sitting Height	ADA Height	Standing Height
18"	SASBM2918-18	SASBM3218-18	SASBM3518-18
24"	SASBM2924-18	SASBM3224-18	SASBM3524-18
30"	SASBM2930-18	SASBM3230-18	SASBM3530-18
36"	SASBM2936-18	SASBM3236-18	SASBM3536-18
42"	SASBM2942-18	SASBM3242-18	SASBM3542-18
48"	SASBM2948-18	SASBM3248-18	SASBM3548-18

Width	Sitting Height	ADA Height	Standing Height
18"	SASBM2918-22	SASBM3218-22	SASBM3518-22
24"	SASBM2924-22	SASBM3224-22	SASBM3524-22
30"	SASBM2930-22	SASBM3230-22	SASBM3530-22
36"	SASBM2936-22	SASBM3236-22	SASBM3536-22
42"	SASBM2942-22	SASBM3242-22	SASBM3542-22
48"	SASBM2948-22	SASBM3248-22	SASBM3548-22

When ordering 18" or 24" wide cabinets please place suffix "L" left or "R" right, after the part number for the hinge placement.

If a Vent Kit is required, use the suffix "VK".

Note: AMS recommends vent kits for all corrosives cabinets. Acids and bases should not be stored in the same cabinet.

Corrosive - Vent Kit

Vent systems shall be manufactured from polyolefin resin and shall conform to ASTM #1412-92 for corrosion resistance and material content. The vent system will contain no PVC or solvents used for assembly. Vent may be constructed using rigid or flexible pipe as required. Vents will be manufactured by Scientific Plastics, Inc. of Kansas City, KS, USA.

403100-VENT KIT

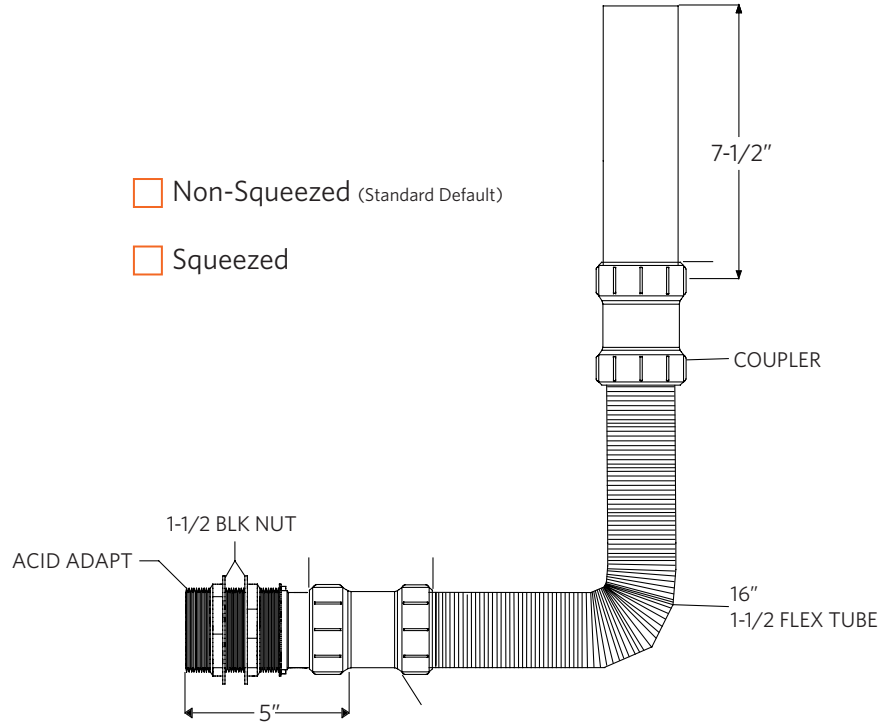

403100-VENT KIT-L

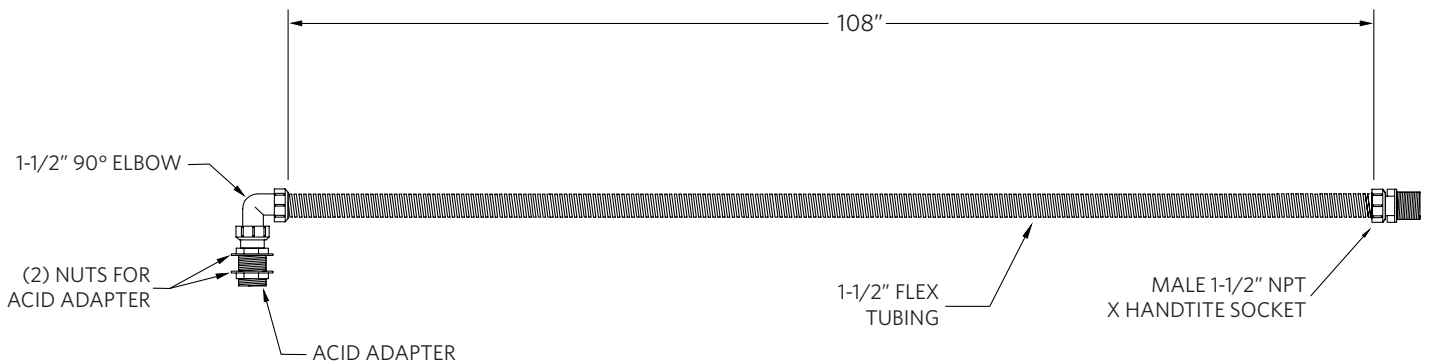

Base Cabinets — Flammables

Flammable storage cabinets are reinforced steel with a hi-tech performance polymer alloy coating, which provides 100% coverage against corrosion. Cabinets are available in 18" and 22" depths. All cabinets have 3 point locking systems.

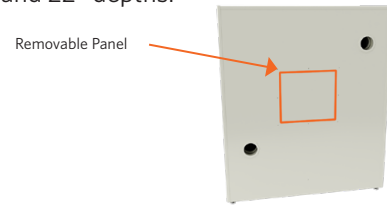

FLAMMABLES STORAGE CABINETS



SFSB2924-18



SFSB2930-18

Width	Sitting Height	ADA Height	Standing Height
24"	SFSB2924-18	SFSB3224-18	SFSB3524-18
30"	SFSB2930-18	SFSB3230-18	SFSB3530-18
36"	SFSB2936-18	SFSB3236-18	SFSB3536-18
42"	SFSB2942-18	SFSB3242-18	SFSB3542-18
48"	SFSB2948-18	SFSB3248-18	SFSB3548-18

Width	Sitting Height	ADA Height	Standing Height
24"	SFSB2924-22	SFSB3224-22	SFSB3524-22
30"	SFSB2930-22	SFSB3230-22	SFSB3530-22
36"	SFSB2936-22	SFSB3236-22	SFSB3536-22
42"	SFSB2942-22	SFSB3242-22	SFSB3542-22
48"	SFSB2948-22	SFSB3248-22	SFSB3548-22

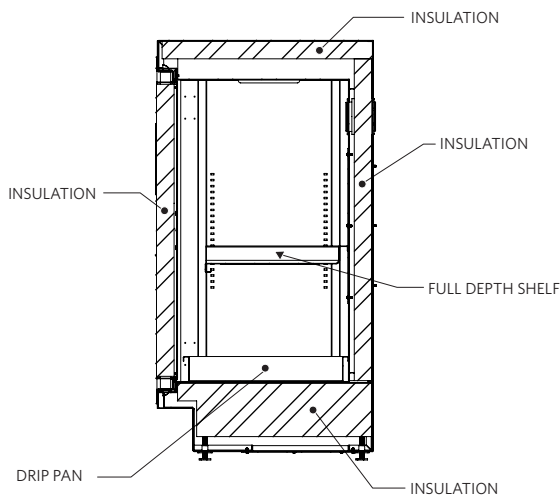

18-3/8" ACTUAL DEPTH

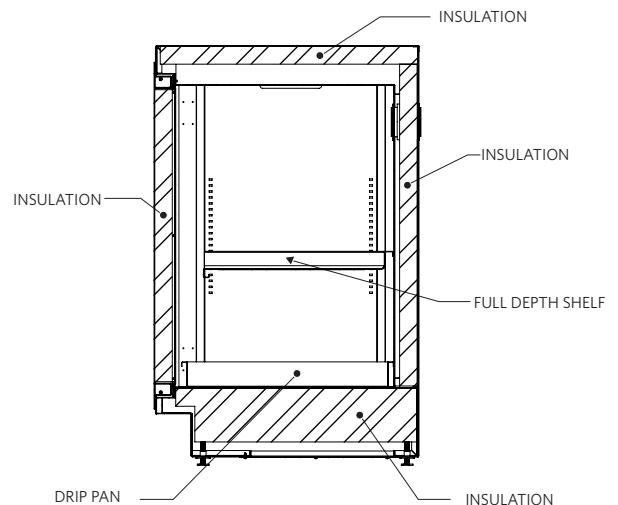

22 3/8" ACTUAL DEPTH

Base Cabinets — Flammables

Flammable storage cabinets are reinforced steel with a hi-tech performance polymer alloy coating, which provides 100% coverage against corrosion. Cabinets are available in 18" and 22" depths. All cabinets have 3 point locking systems.

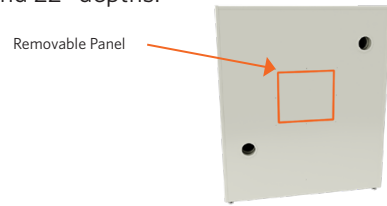

FLAMMABLES STORAGE CABINETS

24" Wide (1 DOOR)

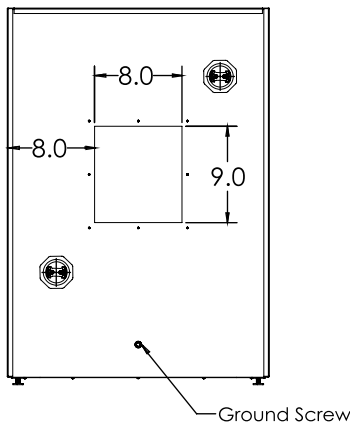

30" Wide (2 DOOR)

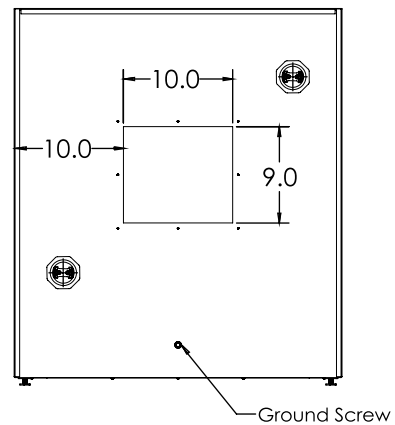

SFSBM3530-18

Mobile cabinets are available. Please contact your AMS representative.

Width	Sitting Height	ADA Height	Standing Height
24"	SFSBM2924-18	SFSBM3224-18	SFSBM3524-18
30"	SFSBM2930-18	SFSBM3230-18	SFSBM3530-18
36"	SFSBM2936-18	SFSBM3236-18	SFSBM3536-18
42"	SFSBM2942-18	SFSBM3242-18	SFSBM3542-18
48"	SFSBM2948-18	SFSBM3248-18	SFSBM3548-18

Width	Sitting Height	ADA Height	Standing Height
24"	SFSBM2924-22	SFSBM3224-22	SFSBM3524-22
30"	SFSBM2930-22	SFSBM3230-22	SFSBM3530-22
36"	SFSBM2936-22	SFSBM3236-22	SFSBM3536-22
42"	SFSBM2942-22	SFSBM3242-22	SFSBM3542-22
48"	SFSBM2948-22	SFSBM3248-22	SFSBM3548-22

Flammables storage cabinets are certified to meet NFPA 30 and are UL listed. Cabinets are available in 18" and 22" depths. For 22" depth, add suffix "-22" to the part number. For synchronized self-closing doors add "-SCC" to the part number. When ordering 24" wide cabinets please place suffix "L" left or "R" right, after the part number for the hinge placement.

Cabinets with self-closing doors are constructed to the UL1275 standards, but do not have a UL label

Vacuum Pump Cabinets

Vacuum Pump Cabinets come with pull-out shelving slides and Polydamp Melamine Foam that has heat resistance and sound dampening qualities. This is applied to the inside of the cabinet. (Please note actual cabinet depth with finished back will be 23.00" and 19.00").



Width	Item Number
15"	SB3515-10V
18"	SB3518-10V
21"	SB3521-10V
24"	SB3524-10V

When ordering single wide cabinets please place suffix "L" left or "R" right, after the part number for the hinge placement.

Attention: All of these units are shipped with a loose unassembled junction box, switch and wiring. These are to be installed by your certified electrician.



Width	Item Number
30"	SB2930-20V-19
36"	SB2936-20V-19
42"	SB2942-20V-19
48"	SB2948-20V-19

Pullout Shelf Dimensions for a SB3524-10V:

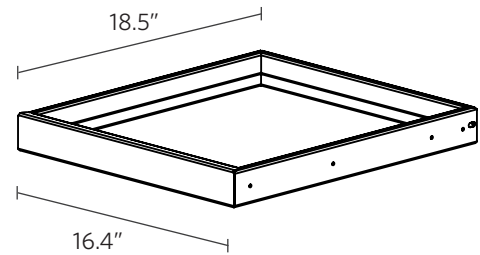

Width	Item Number
30"	SB2930-20V
36"	SB2936-20V
42"	SB2942-20V
48"	SB2948-20V



Width	Item Number
30"	SB3230-20V-19
36"	SB3236-20V-19
42"	SB3242-20V-19
48"	SB3248-20V-19

Width	Item Number
30"	SB3230-20V
36"	SB3236-20V
42"	SB3242-20V
48"	SB3248-20V

Full Cabinet Width	Pullout Shelf Width
15"	7.4"
18"	10.4"
21"	13.4"
24"	16.4"
30"	22.4"
36"	28.4"
42"	34.4"
48"	40.4"



Width	Item Number
30"	SB3530-20V-19
36"	SB3536-20V-19
42"	SB3542-20V-19
48"	SB3548-20V-19

Full Cabinet Depth	Pullout Shelf Depth
19"	14.5"
23"	18.5"

Width	Item Number
30"	SB3530-20V
36"	SB3536-20V
42"	SB3542-20V
48"	SB3548-20V

Vacuum Pump Cabinets

Vacuum Pump Cabinets come with pull-out shelving slides and Polydamp Melamine Foam that has heat resistance and sound dampening qualities. This is applied to the inside of the cabinet. (Please note actual cabinet depth with finished back will be 23.00" and 19.00").



Attention: These units are shipped with a loose unassembled junction box, switch and wiring. These are field installed by your certified electrician.

Attention: Vacuum Cabinet with **NO BOTTOM** has a cart included as a standard item

These units include the cart pictured as part of the unit price. Vent pipe is not included.

Width	Item Number
30"	SB2930-20V-19-NB
36"	SB2936-20V-19-NB
42"	SB2942-20V-19-NB
48"	SB2948-20V-19-NB

Width	Item Number
30"	SB2930-20V-NB
36"	SB2936-20V-NB
42"	SB2942-20V-NB
48"	SB2948-20V-NB

Width	Item Number
30"	SB3230-20V-19-NB
36"	SB3236-20V-19-NB
42"	SB3242-20V-19-NB
48"	SB3248-20V-19-NB

Width	Item Number
30"	SB3230-20V-NB
36"	SB3236-20V-NB
42"	SB3242-20V-NB
48"	SB3248-20V-NB

Width	Item Number
30"	SB3530-20V-19-NB
36"	SB3536-20V-19-NB
42"	SB3542-20V-19-NB
48"	SB3548-20V-19-NB

Width	Item Number
30"	SB3530-20V-NB
36"	SB3536-20V-NB
42"	SB3542-20V-NB
48"	SB3548-20V-NB

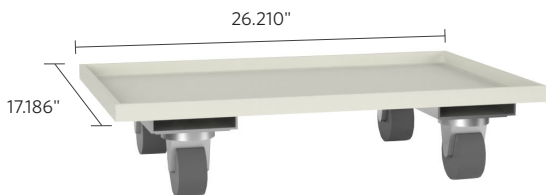

Width	Item Number
24"	MOBILE-CART-24 X23
36"	MOBILE-CART-36 X23

(Standard depth of 23")
*Actual Depth of cart: 17.186"

Width	Item Number
24"	MOBILE-CART-24X19
36"	MOBILE-CART-36X19

(Suffix 19 represents 19" depth)
*Actual Depth of cart: 13.186"

Mobile Cabinets

Most AMS cabinets are available in a mobile version including low profile (27.18" high), sitting height (28.75" high), ADA height (31.75" high), and standing height (34.75" high). They come standard with a finished back and optional finished top. To specify a mobile cabinet use the prefix "M" to the base cabinet model number (example: SMB2724-110). They come standard with a 3" wheel caster and two front casters are locking. There is no height changes to the cabinets when replaced toe kicks with casters. 2" casters are available by adding the suffix "-2" to the part number. Cabinet depth with finished back is 23.00".

All mobile cabinets with drawers come standard with a tip resistant counter weight.

Tops: Please add the suffix "T" for steel, "E" for epoxy, "P" for phenolic. All tops are 3/4" thick and with a 7/8" overhang on front only. **No top overhang for Overlay Mobile Cabinets** (example SMB2724-110L-T)



Mobile Cabinets

Standing height mobile cabinets are 34.75" high and 23.00" deep. Units are available in various widths. Each example below is available in the standard four heights shown on the left. Door units feature a single shelf as standard for standing height cabinets. All open units have 2 shelves. Additional shelves are available. Specify left- or right-hinged doors using the suffix "L" or "R". If locks are required use the suffix "LK".



DOOR & DRAWER CABINETS

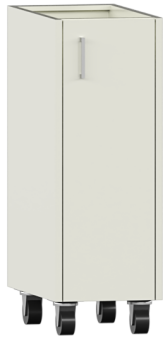

Width	Item Number
12"	SMB3512-100R
15"	SMB3515-100R
18"	SMB3518-100R
21"	SMB3521-100R
24"	SMB3524-100R
12"	SMB3512-100L
15"	SMB3515-100L
18"	SMB3518-100L
21"	SMB3521-100L
24"	SMB3524-100L



Width	Item Number
30"	SMB3530-200
36"	SMB3536-200
42"	SMB3542-200
48"	SMB3548-200



Width	Left & Right Hinged
12"	SMB3512-110L
15"	SMB3515-110L
18"	SMB3518-110L
21"	SMB3521-110L
24"	SMB3524-110L
12"	SMB3512-110R
15"	SMB3515-110R
18"	SMB3518-110R
21"	SMB3521-110R
24"	SMB3524-110R

Note: L(left) or R(right) refers to door hinge side.



Width	Item Number
30"	SMB3530-220
36"	SMB3536-220
42"	SMB3542-220
48"	SMB3548-220



Width	Item Number
30"	SMB3530-210
36"	SMB3536-210
42"	SMB3542-210
48"	SMB3548-210

Suspended Cabinets

Most AMS cabinets are available in a suspended version including low profile (23.18" high), sitting height (24.875" high), ADA height (27.875" high), and standing height (30.875" high). To specify a suspended cabinet use the prefix "H" to the base cabinet model number (example: SHB2324-110). Finished backs are optional and can be specified with the suffix "-FB". Low profile cabinets should be used for adjustable height work benches or table frames on casters to allow the caster to swivel if the adjustable leg is positioned in the lowest setting.



Suspended Cabinets

Standing height suspended cabinets are 30.875" high and 23.00" deep. Units are available in various widths. Each example below is available in the standard four heights shown on the left. Door units feature a single shelf as standard for standard height cabinets. All open units have 2 shelves. Additional shelves are available. Specify left- or right-hinged doors using the suffix "L" or "R". If locks are required use the suffix "LK". If a finished back is required use the suffix "FB".

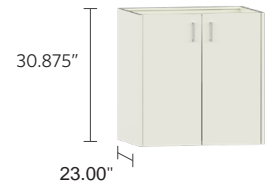

DOOR & DRAWER CABINETS

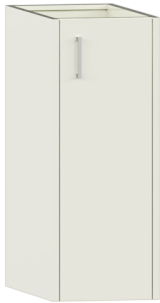

Width	Item Number
12"	SHB3112-100R
15"	SHB3115-100R
18"	SHB3118-100R
21"	SHB3121-100R
24"	SHB3124-100R
12"	SHB3112-100L
15"	SHB3115-100L
18"	SHB3118-100L
21"	SHB3121-100L
24"	SHB3124-100L



Width	Item Number
30"	SHB3130-200
36"	SHB3136-200
42"	SHB3142-200
48"	SHB3148-200



Width	Left & Right Hinged
12"	SHB3112-110L
15"	SHB3115-110L
18"	SHB3118-110L
21"	SHB3121-110L
24"	SHB3124-110L
12"	SHB3112-110R
15"	SHB3115-110R
18"	SHB3118-110R
21"	SHB3121-110R
24"	SHB3124-110R

Note: L(left) or R(right) refers to door hinge side.



Width	Item Number
30"	SHB3130-220
36"	SHB3136-220
42"	SHB3142-220
48"	SHB3148-220



Width	Item Number
30"	SHB3130-210
36"	SHB3136-210
42"	SHB3142-210
48"	SHB3148-210

Overlay Cabinets

All AMS non-speciality cabinets are available in an overlay version including sitting height (28.75" high), ADA height (31.75" high), and standing height (34.75" high). To specify an overlay cabinet, use the prefix "O" to the base cabinet model number (example: SOB2724-110). Overlay cabinets are also available in mobile and suspended variations.



Overlay Cabinets

Standing height overlay base cabinets are 34.75" high and 23.875" deep (Including doors and drawers depth). Units are available in various widths. Each example below is available in the standard four heights shown on the left. Door units feature a single shelf as standard. All open units have 2 shelves. Additional shelves are available. Specify left- or right-hinged doors using the suffix "L" or "R". If locks are required use the suffix "LK".

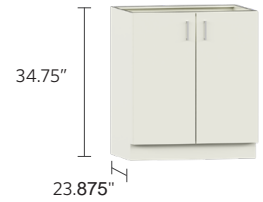

DOOR & DRAWER CABINETS



Width	Item Number
12"	SOB3512-100R
15"	SOB3515-100R
18"	SOB3518-100R
21"	SOB3521-100R
24"	SOB3524-100R
12"	SOB3512-100L
15"	SOB3515-100L
18"	SOB3518-100L
21"	SOB3521-100L
24"	SOB3524-100L



Width	Item Number
30"	SOB3530-200
36"	SOB3536-200
42"	SOB3542-200
48"	SOB3548-200



Width	Left & Right Hinged
12"	SOB3512-110L
15"	SOB3515-110L
18"	SOB3518-110L
21"	SOB3521-110L
24"	SOB3524-110L
12"	SOB3512-110R
15"	SOB3515-110R
18"	SOB3518-110R
21"	SOB3521-110R
24"	SOB3524-110R

Note: L(left) or R(right) refers to door hinge side.



Width	Item Number
30"	SOB3530-220
36"	SOB3536-220
42"	SOB3542-220
48"	SOB3548-220



Width	Item Number
30"	SOB3530-210
36"	SOB3536-210
42"	SOB3542-210
48"	SOB3548-210

Tall Cabinets

Tall cabinets are 84" high and available in 16", 18", 21" and 24" deep by using the two digit suffix. Suffix is not needed when selecting 16" deep. Units are available in various widths as shown. All units feature 5 shelves as standard (middle shelf fixed). Additional shelves are available. Specify left- or right-hinged doors using the suffix "L" or "R" after the two digit depth number. If locks are required use the suffix "LK". Wardrobe cabinets are available by adding the suffix "W" to any of the standard part numbers. They will include one hanging bar in lieu of shelves. For pull out shelves add the suffix "PS".

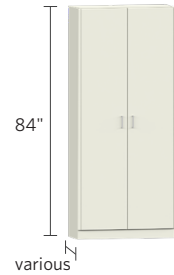

OPEN CABINETS



Up to 24" wide

Width	Item Number
18"	SF8418-000
24"	SF8424-000



30" and wider

Width	Item Number
30"	SF8430-000
36"	SF8436-000
42"	SF8442-000
48"	SF8448-000

DOOR CABINETS



Right-hinged door shown

Width	Left & Right Hinged
18"	SF8418-1SHL
24"	SF8424-1SHL
18"	SF8418-1SHR
24"	SF8424-1SHR



Width	Item Number
30"	SF8430-2SH
36"	SF8436-2SH
42"	SF8442-2SH
48"	SF8448-2SH



Width	Item Number
30"	SF8430-2SS
36"	SF8436-2SS
42"	SF8442-2SS
48"	SF8448-2SS

(this unit has sliding doors)



Width	Item Number
30"	SF8430-4SH
36"	SF8436-4SH
42"	SF8442-4SH
48"	SF8448-4SH

Tall Cabinets

Tall cabinets are 84" high and available in 16", 18", 21" and 24" deep by using the two digit suffix. Suffix is not needed when selecting 16" deep. Units are available in various widths as shown. All units feature five shelves as standard (middle shelf fixed). Additional shelves are available. Specify left- or right-hinged doors using the suffix "L" or "R" after the two digit depth number. If locks are required use the suffix "LK". Wardrobe cabinets are available by adding the suffix "W" to any of the standard part numbers. They will include one hanging bar in lieu of shelves. For pull out shelves add the suffix "PS".

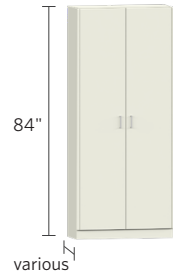

DOOR CABINETS



Width	Left & Right Hinged
18"	SF8418-1GHL
24"	SF8424-1GHL
18"	SF8418-1GHR
24"	SF8424-1GHR

Right-hinged door shown



Width	Item Number
30"	SF8430-2GH
36"	SF8436-2GH
42"	SF8442-2GH
48"	SF8448-2GH



Width	Item Number
30"	SF8430-2GSF
36"	SF8436-2GSF
42"	SF8442-2GSF
48"	SF8448-2GSF

(this unit has sliding doors)



Width	Item Number
30"	SF8430-4GH
36"	SF8436-4GH
42"	SF8442-4GH
48"	SF8448-4GH



Width	Item Number
30"	SF8430-2GH2SH
36"	SF8436-2GH2SH
42"	SF8442-2GH2SH
48"	SF8448-2GH2SH



Pull out shelves are available upon request.

Wall Cabinets — 24" Height

Wall cabinets are available in 24", 30", 36" and 48" heights and come standard with a 13" depth. For 16" deep cabinets, use the suffix "16". Units are available in various widths as shown. They feature one shelf as standard for 24" units. Specify left- or right-hinged doors using the suffix "L" or "R" after the two digit depth number. If locks are required, use the suffix "LK".

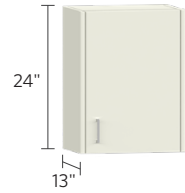

Example: **SW2430-2SS-16** — Depth

Height: 24" (from SW2430-2SS-16)
 # of Doors: 2 (from SW2430-2SS-16)
 Width: 30" (from SW2430-2SS-16)
 Door Style: SS (from SW2430-2SS-16)

OPEN CABINETS



Up to 24" wide

Width	Item Number
18"	SW2418-000
24"	SW2424-000



30" and wider

Width	Item Number
30"	SW2430-000
36"	SW2436-000
42"	SW2442-000
48"	SW2448-000

STEEL-HINGED DOOR CABINETS



Right-hinged door shown

Width	Left & Right Hinged
18"	SW2418-1SHL
24"	SW2424-1SHL
18"	SW2418-1SHR
24"	SW2424-1SHR



30" and wider

Width	Item Number
30"	SW2430-2SH
36"	SW2436-2SH
42"	SW2442-2SH
48"	SW2448-2SH

STEEL SLIDING DOOR CABINETS



30" and wider

Width	Item Number
30"	SW2430-2SS
36"	SW2436-2SS
42"	SW2442-2SS
48"	SW2448-2SS

CORNER CABINETS



Item Number
SWC2418-000



Left Hinged	Right Hinged
SWC2418-1SHL	SWC2418-1SHR

Right-hinged door shown



Left Hinged	Right Hinged
SWC2418-1GHL	SWC2418-1GHR

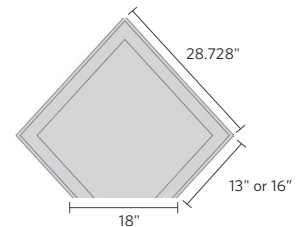

*Lazy Susan Add-On
 Suffix "LS"

Wall Cabinets — 24" Height

Wall cabinets are available in 24", 30", 36" and 48" heights and come standard with a 13" depth. For 16" deep cabinets, use the suffix "16". Units are available in various widths as shown. They feature one shelf as standard for 24" units. Specify left- or right-hinged doors using the suffix "L" or "R" after the two digit depth number. If locks are required, use the suffix "LK".

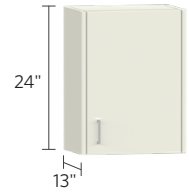

Example: **SW2430-2SS-16** — Depth

Labels: Height (24), # of Doors (2), Width (30), Door Style (SS), Depth (16)

FRAMED GLASS HINGED DOOR CABINETS



Right-hinged door shown

Width	Left & Right Hinged
18"	SW2418-1GHL
24"	SW2424-1GHL
18"	SW2418-1GHR
24"	SW2424-1GHR



30" and wider

Width	Item Number
30"	SW2430-2GH
36"	SW2436-2GH
42"	SW2442-2GH
48"	SW2448-2GH

FRAMED GLASS SLIDING DOOR CABINETS



30" and wider

Width	Item Number
30"	SW2430-2GSF
36"	SW2436-2GSF
42"	SW2442-2GSF
48"	SW2448-2GSF

GLASS SLIDING DOOR CABINETS



30" and wider

Width	Item Number
30"	SW2430-2GS
36"	SW2436-2GS
42"	SW2442-2GS
48"	SW2448-2GS

Wall Cabinets — 30" Height

Wall cabinets are available in 24", 30", 36" and 48" heights and come standard with a 13" depth. For 16" deep cabinets, use the suffix "16". Units are available in various widths as shown. They feature two shelves as standard for 30" units. Specify left- or right-hinged doors using the suffix "L" or "R" after the two digit depth number. If locks are required, use the suffix "LK".

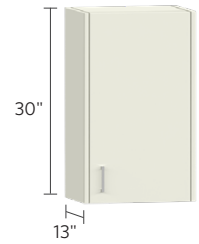
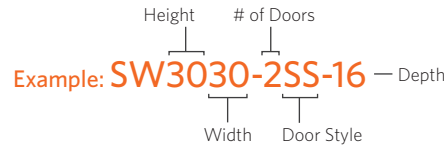

OPEN CABINETS



Up to 24" wide

Width	Item Number
18"	SW3018-000
24"	SW3024-000



30" and wider

Width	Item Number
30"	SW3030-000
36"	SW3036-000
42"	SW3042-000
48"	SW3048-000

STEEL-HINGED DOOR CABINETS



Right-hinged door shown

Width	Left & Right Hinged
18"	SW3018-1SHL
24"	SW3024-1SHL
18"	SW3018-1SHR
24"	SW3024-1SHR



30" and wider

Width	Item Number
30"	SW3030-2SH
36"	SW3036-2SH
42"	SW3042-2SH
48"	SW3048-2SH

STEEL SLIDING DOOR CABINETS



30" and wider

Width	Item Number
30"	SW3030-2SS
36"	SW3036-2SS
42"	SW3042-2SS
48"	SW3048-2SS

CORNER CABINETS

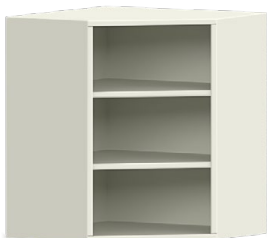

Item Number
SWC3018-000



Left Hinged	Right Hinged
SWC3018-1SHL	SWC3018-1SHR

Right-hinged door shown

*Lazy Susan Add-On Suffix "LS"



Left Hinged	Right Hinged
SWC3018-1GHL	SWC3018-1GHR

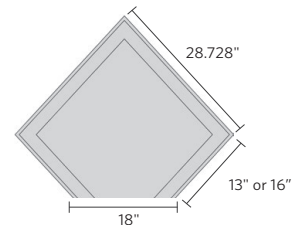

Wall Cabinets — 30" Height

Wall cabinets are available in 24", 30", 36" and 48" heights and come standard with a 13" depth. For 16" deep cabinets, use the suffix "16". Units are available in various widths as shown. They feature two shelves as standard for 30" units. Specify left- or right-hinged doors using the suffix "L" or "R" after the two digit depth number. If locks are required, use the suffix "LK".

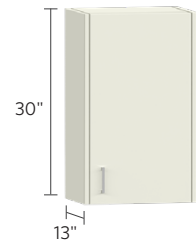
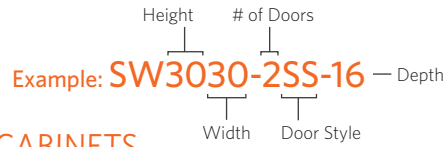

FRAMED GLASS HINGED DOOR CABINETS



Right-hinged door shown

Width	Left & Right Hinged
18"	SW3018-1GHL
24"	SW3024-1GHL
18"	SW3018-1GHR
24"	SW3024-1GHR



30" and wider

Width	Item Number
30"	SW3030-2GH
36"	SW3036-2GH
42"	SW3042-2GH
48"	SW3048-2GH

FRAMED GLASS SLIDING DOOR CABINETS



30" and wider

Width	Item Number
30"	SW3030-2GSF
36"	SW3036-2GSF
42"	SW3042-2GSF
48"	SW3048-2GSF

GLASS SLIDING DOOR CABINETS



30" and wider

Width	Item Number
30"	SW3030-2GS
36"	SW3036-2GS
42"	SW3042-2GS
48"	SW3048-2GS

Wall Cabinets — 36" Height

Wall cabinets are available in 24", 30", 36" and 48" heights and come standard with a 13" depth. For 16" deep cabinets, use the suffix "16". Units are available in various widths as shown. They feature two shelves as standard for 36" units. Specify left- or right-hinged doors using the suffix "L" or "R" after the two digit depth number. If locks are required, use the suffix "LK".

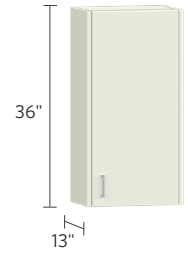

Example: **SW3630-2SS-16**

Height: 36" | # of Doors: 2 | Width: 30" | Door Style: SS | Depth: 16"

OPEN CABINETS



Width	Item Number
18"	SW3618-000
24"	SW3624-000

Up to 24" wide



Width	Item Number
30"	SW3630-000
36"	SW3636-000
42"	SW3642-000
48"	SW3648-000

30" and wider

STEEL-HINGED DOOR CABINETS



Width	Left & Right Hinged
18"	SW3618-1SHL
24"	SW3624-1SHL
18"	SW3618-1SHR
24"	SW3624-1SHR

Right-hinged door shown



Width	Item Number
30"	SW3630-2SH
36"	SW3636-2SH
42"	SW3642-2SH
48"	SW3648-2SH

30" and wider

STEEL SLIDING DOOR CABINETS



Width	Item Number
30"	SW3630-2SS
36"	SW3636-2SS
42"	SW3642-2SS
48"	SW3648-2SS

30" and wider

CORNER CABINETS



Item Number
SWC3618-000



Left Hinged	Right Hinged
SWC3618-1SHL	SWC3618-1SHR

Right-hinged door shown

*Lazy Susan Add-On Suffix "LS"



Left Hinged	Right Hinged
SWC3618-1GHL	SWC3618-1GHR

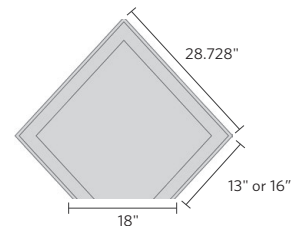

Wall Cabinets — 36" Height

Wall cabinets are available in 24", 30", 36" and 48" heights and come standard with a 13" depth. For 16" deep cabinets, use the suffix "16". Units are available in various widths as shown. They feature two shelves as standard for 36" units. Specify left- or right-hinged doors using the suffix "L" or "R" after the two digit depth number. If locks are required, use the suffix "LK".

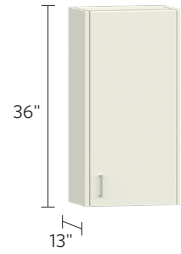
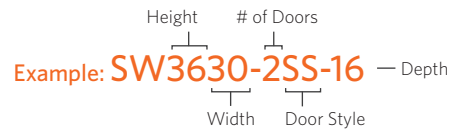

FRAMED GLASS HINGED DOOR CABINETS



Right-hinged door shown

Width	Left & Right Hinged
18"	SW3618-1GHL
24"	SW3624-1GHL
18"	SW3618-1GHR
24"	SW3624-1GHR



30" and wider

Width	Item Number
30"	SW3630-2GH
36"	SW3636-2GH
42"	SW3642-2GH
48"	SW3648-2GH

FRAMED GLASS SLIDING DOOR CABINETS



30" and wider

Width	Item Number
30"	SW3630-2GSF
36"	SW3636-2GSF
42"	SW3642-2GSF
48"	SW3648-2GSF

GLASS SLIDING DOOR CABINETS



30" and wider

Width	Item Number
30"	SW3630-2GS
36"	SW3636-2GS
42"	SW3642-2GS
48"	SW3648-2GS

Wall Cabinets — 48" Height

Wall cabinets are available in 24", 30", 36" and 48" heights and come standard with a 13" depth. For 16" deep cabinets, use the suffix "16". Units are available in various widths as shown. They feature three shelves as standard for 48" units. Specify left- or right-hinged doors using the suffix "L" or "R" after the two digit depth number. If locks are required, use the suffix "LK".

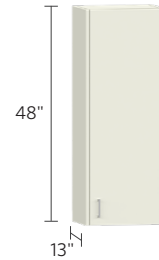

Example: **SW4830-2SS-16**

Height: 48" | # of Doors: 2 | Depth: 16" | Width: 30" | Door Style: SS

OPEN CABINETS



Width	Item Number
18"	SW4818-000
24"	SW4824-000

Up to 24" wide



30" and wider

Width	Item Number
30"	SW4830-000
36"	SW4836-000
42"	SW4842-000
48"	SW4848-000

STEEL-HINGED DOOR CABINETS



Width	Left & Right Hinged
18"	SW4818-1SHL
24"	SW4824-1SHL
18"	SW4818-1SHR
24"	SW4824-1SHR

Right-hinged door shown

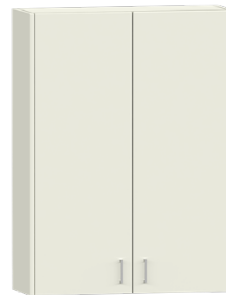

30" and wider

Width	Item Number
30"	SW4830-2SH
36"	SW4836-2SH
42"	SW4842-2SH
48"	SW4848-2SH

STEEL SLIDING DOOR CABINETS



Width	Item Number
30"	SW4830-2SS
36"	SW4836-2SS
42"	SW4842-2SS
48"	SW4848-2SS

CORNER CABINETS



Item Number
SWC4818-000

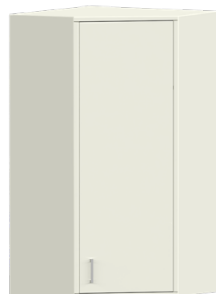

Left Hinged	Right Hinged
SWC4818-1SHL	SWC4818-1SHR

Right-hinged door shown

*Lazy Susan Add-On Suffix "LS"



Left Hinged	Right Hinged
SWC4818-1GHL	SWC4818-1GHR

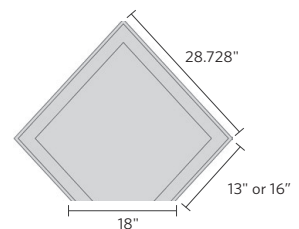

Wall Cabinets — 48" Height

Wall cabinets are available in 24", 30", 36" and 48" heights and come standard with a 13" depth. For 16" deep cabinets, use the suffix "16". Units are available in various widths as shown. They feature three shelves as standard for 48" units. Specify left- or right-hinged doors using the suffix "L" or "R" after the two digit depth number. If locks are required, use the suffix "LK".

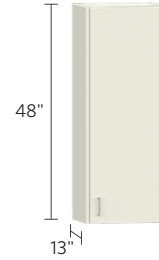

Example: **SW4830-2SS-16** — Depth
 Height: 48", # of Doors: 2, Width: 30", Door Style: SS-16

FRAMED GLASS HINGED DOOR CABINETS



Right-hinged door shown

Width	Left & Right Hinged
18"	SW4818-1GHL
24"	SW4824-1GHL
18"	SW4818-1GHR
24"	SW4824-1GHR



30" and wider

Width	Item Number
30"	SW4830-2GH
36"	SW4836-2GH
42"	SW4842-2GH
48"	SW4848-2GH

FRAMED GLASS SLIDING DOOR CABINETS



30" and wider

Width	Item Number
30"	SW4830-2GSF
36"	SW4836-2GSF
42"	SW4842-2GSF
48"	SW4848-2GSF

GLASS SLIDING DOOR CABINETS

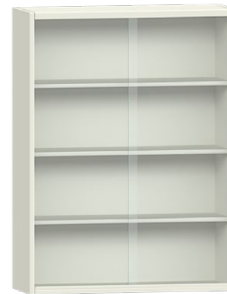

30" and wider

Width	Item Number
30"	SW4830-2GS
36"	SW4836-2GS
42"	SW4842-2GS
48"	SW4848-2GS

Aprons

Aprons have the options to be ordered in depths of 22" and 28". The aprons can have up to three drawers if the width allows. If end covers are required, use the suffix "EC". Actual depth of an apron is 22.627 and 28".

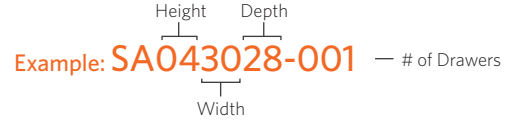

UTILITY TABLES



Width	Item Number
24"	SA042422-000
30"	SA043022-000
36"	SA043622-000
42"	SA044222-000
48"	SA044822-000
54"	SA045422-000
60"	SA046022-000
66"	SA046622-000
72"	SA047222-000



Width	Item Number	Item Number
24"	SA042422-001	SA042428-001
30"	SA043022-001	SA043028-001
36"	SA043622-001	SA043628-001
42"	SA044222-001	SA044228-001



Width	Item Number	Item Number
42"	SA044222-002	SA044228-002
48"	SA044822-002	SA044828-002
54"	SA045422-002	SA045428-002
60"	SA046022-002	SA046028-002
66"	SA046622-002	SA046628-002
72"	SA047222-002	SA047228-002



Width	Item Number	Item Number
72"	SA047222-003	SA047228-003

Utility Tables

Utility Tables can be ordered in 29", 32", and 35" height. The frame Width (A) is 2" less than nominal size. The frame depth (B) can be 22"(22.625) deep and 28" deep. SUTXXXXXX-__ The number of drawers are indicated by the last three numbers. The drawers are available as 000(No Drawers), 001(One Drawer), 002 (Two Drawers), and 003(Three Drawers). Utility Tables are shipped unassembled.

Example: **SUT293024-001** — # of Drawers

Height
Depth
|
|
└───┘
└───┘
Width
Width

UTILITY TABLES

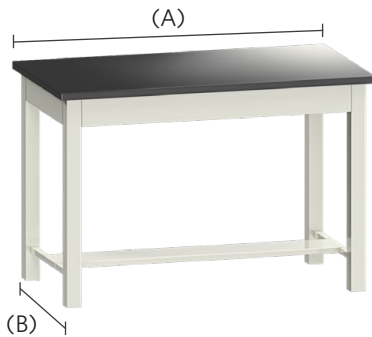

Width	Item Number	(A)	(B)	Item Number	(A)	(B)
24"	SUT292424-000	22	22.625	SUT292430-000	22	28
30"	SUT293024-000	28	22.625	SUT293030-000	28	28
36"	SUT293624-000	34	22.625	SUT293630-000	34	28
42"	SUT294224-000	40	22.625	SUT294230-000	40	28
48"	SUT294824-000	46	22.625	SUT294830-000	46	28
54"	SUT295424-000	52	22.625	SUT295430-000	52	28
60"	SUT296024-000	58	22.625	SUT296030-000	58	28
66"	SUT296624-000	64	22.625	SUT296630-000	64	28
72"	SUT297224-000	70	22.625	SUT297230-000	70	28

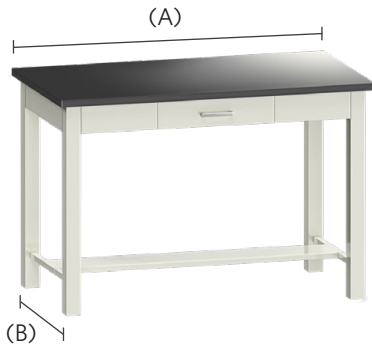

Width	Item Number	(A)	(B)	Item Number	(A)	(B)
30"	SUT293024-001	28	22.625	SUT293030-001	28	28
36"	SUT293624-001	34	22.625	SUT293630-001	34	28
42"	SUT294224-001	40	22.625	SUT294230-001	40	28

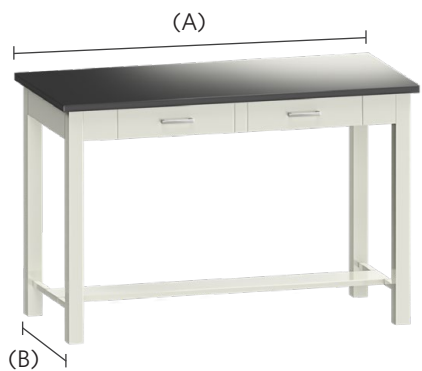

Width	Item Number	(A)	(B)	Item Number	(A)	(B)
42"	SUT294224-002	40	22.625	SUT294230-002	40	28
48"	SUT294824-002	46	22.625	SUT294830-002	46	28
54"	SUT295424-002	52	22.625	SUT295430-002	52	28
60"	SUT296024-002	58	22.625	SUT296030-002	58	28
66"	SUT296624-002	64	22.625	SUT296630-002	64	28
72"	SUT297224-002	70	22.625	SUT297230-002	70	28

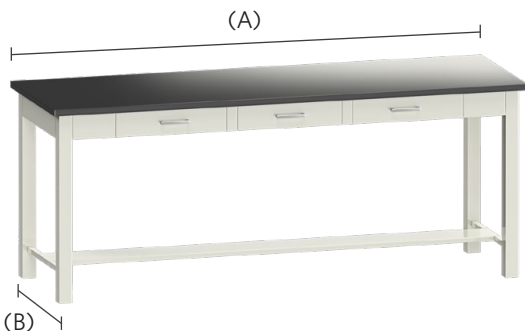

Width	Item Number	(A)	(B)	Item Number	(A)	(B)
72"	SUT297224-003	70	22.625	SUT297230-003	70	28

Filler Panels

Base cabinet filler panels are available in 29", 32" and 35" high. Floor case filler panels are available in 84" high. They are all available in any width (1/8" increments) required by entering the dimension in lieu of the "XX" in the part number.

Note: AMS base cabinets are 23.00" deep. (Example: SLF35-6)

C-FILLER



Item Number	Item Number	Item Number
SCF29-XX	SCF32-XX	SCF35-XX

C-FRONT FILLER



Item Number	Item Number	Item Number
SFFC29-XX	SFFC32-XX	SFFC35-XX

L-FILLER



Item Number	Item Number	Item Number
SLF29-XX	SLF32-XX	SLF35-XX

L-FRONT FILLER



Item Number	Item Number	Item Number
SFFL29-XX	SFFL32-XX	SFFL35-XX

Filler Panels

Base cabinet filler panels are available in 29", 32" and 35" high. Floor case filler panels are available in 84" high. They are all available in any width (1/8" increments) required by entering the dimension in lieu of the "XX" in the part number.

Note: AMS base cabinets are 23.00" deep. (Example: SLF35-6)

CORNER FILLER



Item Number	Item Number	Item Number
SICF29-XX	SICF32-XX	SICF35-XX

FLOOR CASE FILLER



Item Number
SFFL84-XX

TOE SPACE FILLER



Item Number
STSF-XX

WALL CASE FRONT FILLER



Item Number	Item Number	Item Number	Item Number
SWCFF24-XX	SWCFF30-XX	SWCFF36-XX	SWCFF48-XX

Wall cabinet front filler panels are available in 24", 30", 36" and 48" high. They are all available in any width (1/8" increments) required by entering the dimension in lieu of the "XX" in the part number. To specify the depth use the suffix "-13" or "-16".

WALL CASE CORNER FILLER

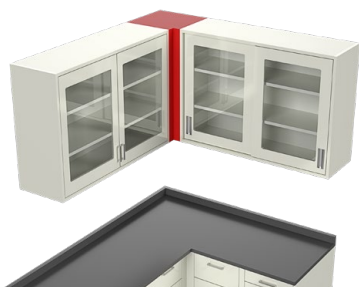

Item Number	Item Number	Item Number	Item Number
SWCCF24	SWCCF30	SWCCF36	SWCCF48

Knee Space Rails And Panels

KNEE SPACE RAILS



Item Number
SKSR0418
SKSR0424
SKSR0430
SKSR0436
SKSR0442
SKSR0448
SKSR0452
SKSR0454
SKSR0460
SKSR0466
SKSR0472
SKSR0484
SKSR0496

KNEE SPACE PANELS



The suffix "-2P" represents two piece panels.



The suffix "-3P" represents three piece panels.

29" Height	32" Height	35" Height
SKSP2924	SKSP3224	SKSP3524
SKSP2930	SKSP3230	SKSP3530
SKSP2936	SKSP3236	SKSP3536
SKSP2942	SKSP3242	SKSP3542
SKSP2948	SKSP3248	SKSP3548
SKSP2954	SKSP3254	SKSP3554
SKSP2960	SKSP3260	SKSP3560
SKSP2966	SKSP3266	SKSP3566
SKSP2972	SKSP3272	SKSP3572

29" Height	32" Height	35" Height
SKSP2924-2P	SKSP3224-2P	SKSP3524-2P
SKSP2930-2P	SKSP3230-2P	SKSP3530-2P
SKSP2936-2P	SKSP3236-2P	SKSP3536-2P
SKSP2942-2P	SKSP3242-2P	SKSP3542-2P
SKSP2948-2P	SKSP3248-2P	SKSP3548-2P
SKSP2954-2P	SKSP3254-2P	SKSP3554-2P
SKSP2960-2P	SKSP3260-2P	SKSP3560-2P
SKSP2966-2P	SKSP3266-2P	SKSP3566-2P
SKSP2972-2P	SKSP3272-2P	SKSP3572-2P

29" Height	32" Height	35" Height
SKSP2924-3P	SKSP3224-3P	SKSP3524-3P
SKSP2930-3P	SKSP3230-3P	SKSP3530-3P
SKSP2936-3P	SKSP3236-3P	SKSP3536-3P
SKSP2942-3P	SKSP3242-3P	SKSP3542-3P
SKSP2948-3P	SKSP3248-3P	SKSP3548-3P
SKSP2954-3P	SKSP3254-3P	SKSP3554-3P
SKSP2960-3P	SKSP3260-3P	SKSP3560-3P
SKSP2966-3P	SKSP3266-3P	SKSP3566-3P
SKSP2972-3P	SKSP3272-3P	SKSP3572-3P

Knee Space Rails And Panels

KNEE SPACE PANELS - APRON SIZING

To accommodate aprons with drawer housing, knee space panels must be 4 inches smaller than the cabinet height.



The suffix "-2P" represents two piece panels.



The suffix "-3P" represents three piece panels.

25" Height	28" Height	31" Height
SKSP2524	SKSP2824	SKSP3124
SKSP2530	SKSP2830	SKSP3130
SKSP2536	SKSP2836	SKSP3136
SKSP2542	SKSP2842	SKSP3142
SKSP2548	SKSP2848	SKSP3148
SKSP2554	SKSP2854	SKSP3154
SKSP2560	SKSP2860	SKSP3160
SKSP2566	SKSP2866	SKSP3166
SKSP2572	SKSP2872	SKSP3172

25" Height	28" Height	31" Height
SKSP2524-2P	SKSP2824-2P	SKSP3124-2P
SKSP2530-2P	SKSP2830-2P	SKSP3130-2P
SKSP2536-2P	SKSP2836-2P	SKSP3136-2P
SKSP2542-2P	SKSP2842-2P	SKSP3142-2P
SKSP2548-2P	SKSP2848-2P	SKSP3148-2P
SKSP2554-2P	SKSP2854-2P	SKSP3154-2P
SKSP2560-2P	SKSP2860-2P	SKSP3160-2P
SKSP2566-2P	SKSP2866-2P	SKSP3166-2P
SKSP2572-2P	SKSP2872-2P	SKSP3172-2P

25" Height	28" Height	31" Height
SKSP2524-3P	SKSP2824-3P	SKSP3124-3P
SKSP2530-3P	SKSP2830-3P	SKSP3130-3P
SKSP2536-3P	SKSP2836-3P	SKSP3136-3P
SKSP2542-3P	SKSP2842-3P	SKSP3142-3P
SKSP2548-3P	SKSP2848-3P	SKSP3148-3P
SKSP2554-3P	SKSP2854-3P	SKSP3154-3P
SKSP2560-3P	SKSP2860-3P	SKSP3160-3P
SKSP2566-3P	SKSP2866-3P	SKSP3166-3P
SKSP2572-3P	SKSP2872-3P	SKSP3172-3P

CABINET FINISHED BACKS

Cabinet finished back - toe kick

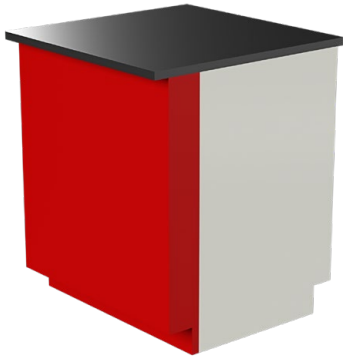

Cabinet finished back - no toe kick

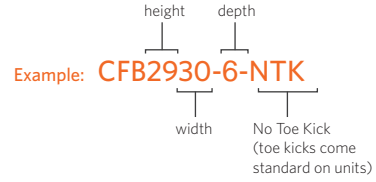
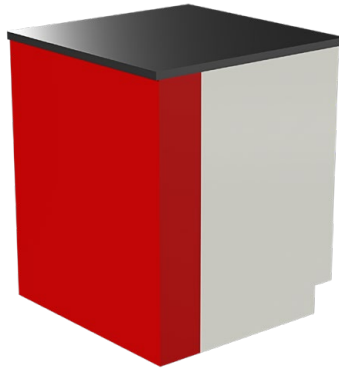

Cabinet finished backs come standard with a toe kick. Finished backs can be applied to a multitude of cabinets. The example above represents the layout for the part number. The height, width, and depth must match the cabinet that the finished back is to be applied too. If you do not want a toe kick on your unit be sure to put the suffix "NTK" at the end of the part number.

Counter Island Reagent Assembly

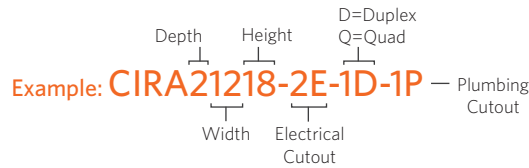

Item Number
CIRA21218

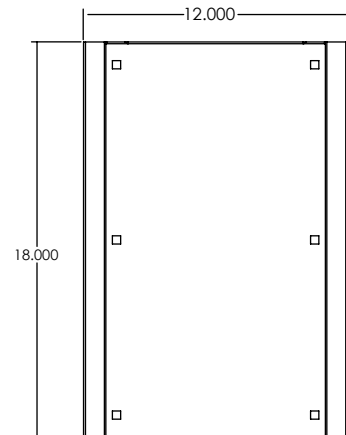
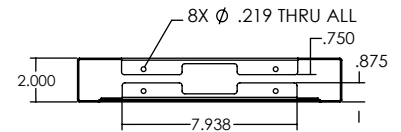

Accessories

END PEDESTALS



Item Number
SEP2902-23
SEP2902-28
SEP3502-23
SEP3502-28

TABLE LEGS



Item Number
SL29-28
SL35-22
SL35-28

Actual: 22.625"

SINGLE LEG



Item Number
SSL-29
SSL-35



SINGLE LEG WITH PLATE

Item Number
SSL-29P
SSL-35P

CORNER SLOPED TOP



Item Number
SST-Corner13
SST-Corner16
SST-Corner21

SLOPED TOP WITH END CAPS



Item Number	Item Number	Item Number
SST13-18	SST16-18	SST21-18
SST13-24	SST16-24	SST21-24
SST13-30	SST16-30	SST21-30
SST13-36	SST16-36	SST21-36
SST13-42	SST16-42	SST21-42
SST13-48	SST16-48	SST21-48

*Slope height is 6"

SHELVES



Item Number	Item Number	Item Number	Item Number
SWS1813	SWS1816	SFS1816	SFS1821
SWS2413	SWS2416	SFS2416	SFS2421
SWS3013	SWS3016	SFS3016	SFS3021
SWS3613	SWS3616	SFS3616	SFS3621
SWS4213	SWS4216	SFS4216	SFS4221
SWS4813	SWS4816	SFS4816	SFS4821
Wall Case Shelves		Floor Case Shelves	

Cylinder Racks

CYLINDER RESTRAINT RACKS

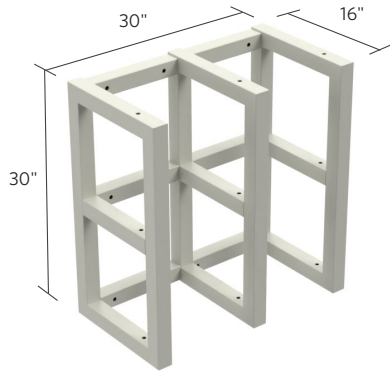

SCR02-1 Cylinder Rack Shown

Width	Item Number	# of Cylinders
16"	SCR01-1	1
30"	SCR02-1	2
44"	SCR03-1	3
58"	SCR04-1	4
72"	SCR05-1	5

*Custom sizes available

*Includes chains

** Standard construction is welded.

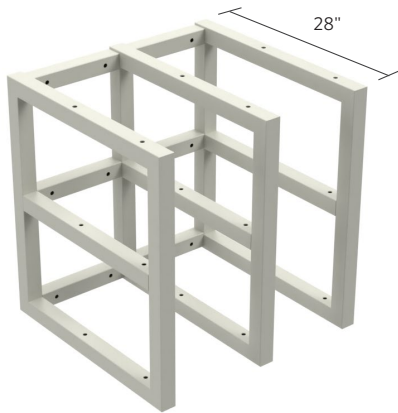

SCR02-2 Cylinder Rack Shown

Width	Item Number	# of Cylinders
16"	SCR01-2	2
30"	SCR02-2	4
44"	SCR03-2	6
58"	SCR04-2	8
72"	SCR05-2	10

*Custom sizes available

*Includes chains

** Standard construction is welded.

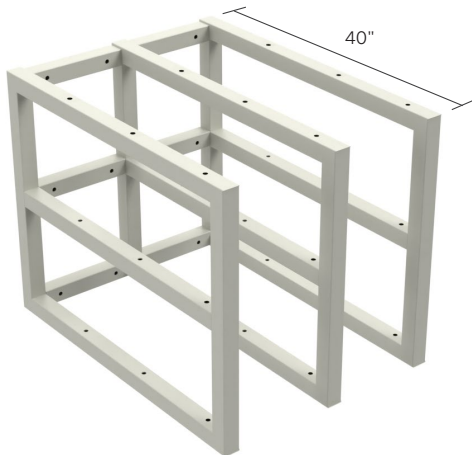

SCR02-3 Cylinder Rack Shown

Width	Item Number	# of Cylinders
16"	SCR01-3	3
30"	SCR02-3	6
44"	SCR03-3	9
58"	SCR04-3	12
72"	SCR05-3	15

*Custom sizes available

*Includes chains

** Standard construction is welded.

Umbilicals

ISLAND UMBILICALS

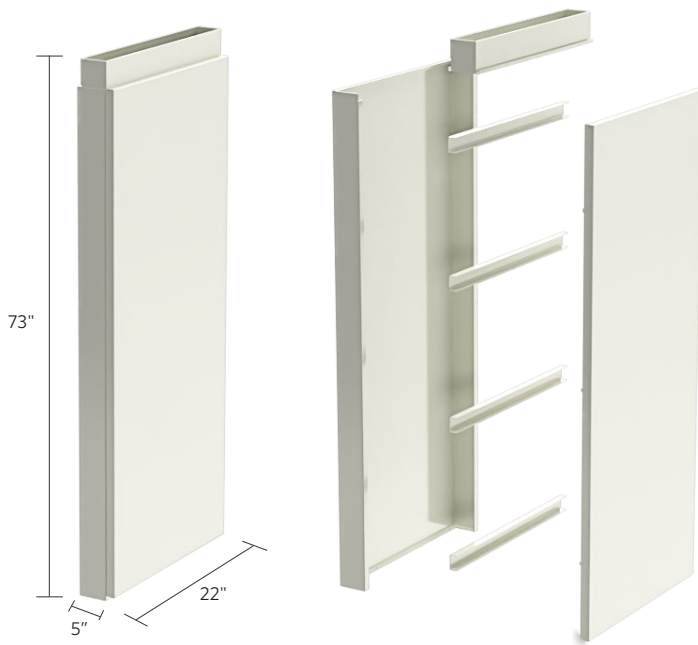

UMB-IR-22X5X73 Shown

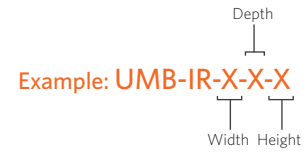

Height	Item Number
68"	UMB-IR-X-X-68
73"	UMB-IR-X-X-73
78"	UMB-IR-X-X-78
90"	UMB-IR-X-X-90

WALL UMBILICALS

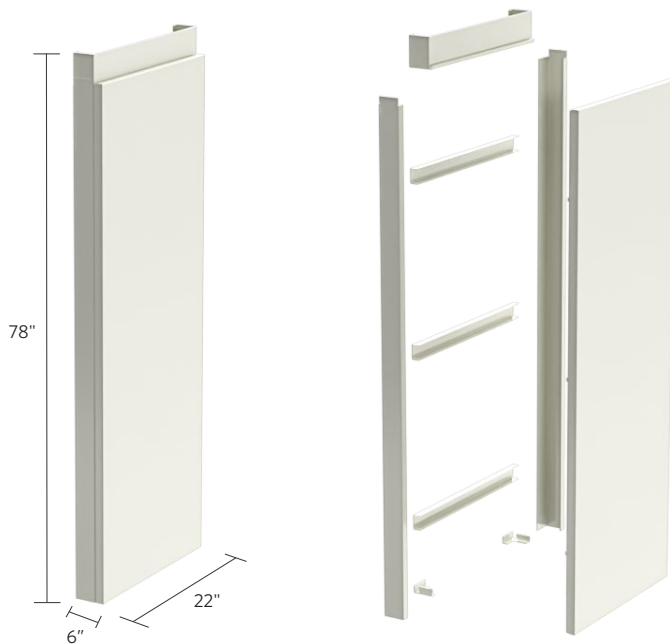

UMB-WR-22X6X78 Shown



Height	Item Number
68"	UMB-WR-X-X-68
73"	UMB-WR-X-X-73
78"	UMB-WR-X-X-78
90"	UMB-WR-X-X-90



Air Master Systems Corp.

6480 Norton Center Drive, Muskegon, MI 49441 • 231.798.1111 • 231.798.4000 fax • airmastersystems.com